

MAINTENANCE SERVICE MANUAL FTC-2640

SAME AS SMC 2515L8



YAESU MUSEN CO.,LTD.

For Service Manuals Contact
MAURITRON TECHNICAL SERVICES
8 Cherry Tree Rd, Chinnor
Oxon OX9 4QY
Tel:- 01844-351694 Fax:- 01844-352554
Email:- enquiries@mauritron.co.uk

MAINTENANCE SERVICE MANUAL FTC-2640



YAESU MUSEN CO., LTD.

For Service Manuals Contact
MAURITRON TECHNICAL SERVICES
8 Cherry Tree Rd, Chinnor
Oxon OX9 4QY
Tel:- 01844-351694 Fax:- 01844-352554
Email:- enquiries@mauritron.co.uk

PREFACE

The purpose of this manual is to provide information critical to the long-term operation and maintenance of the FTC-2640 VHF FM Mobile Transceiver. In the interest of clarity, descriptions have been kept brief and somewhat informal, while photographs and drawings are utilized liberally.

We believe the material presented herein to be correct and factual. However, should typographical or other errors be present, Yaesu assumes no liability for damage resulting from such errors. Your cooperation in pointing out any inconsistencies in the technical information would be appreciated.

The rugged, straightforward design of the FTC-2640 makes it unlikely that you will have frequent recourse to this manual. We hope and trust, however, that the material to follow will meet your service requirements.

For Service Manuals Contact
MAURITRON TECHNICAL SERVICES
8 Cherry Tree Rd, Chinnor
Oxon OX9 4QY
Tel:- 01844-351694 Fax:- 01844-352554
Email:- enquiries@mauritron.co.uk

Yaesu Musen Company, Ltd.
Tokyo, Japan

IMPORTANT NOTE

Any adjustments to the FTC-2640 which affect the transmitter characteristics or operating frequency must be performed only by an FCC licensed technician holding a Second Class (or higher) certificate.

Copyright © 1981
Yaesu Musen Company, Ltd.
All Rights Reserved

No portion of this manual may be reproduced in any form without written permission of Yaesu Musen Co., Ltd.

CONTENTS

	(Page)
PREFACE	i
SECTION 1 – GENERAL	
GENERAL DESCRIPTION	1-1
PERFORMANCE SPECIFICATIONS	1-2
SEMICONDUCTORS	1-3
FRONT PANEL CONTROLS AND SWITCHES	1-4
REAR APRON CONNECTIONS	1-5
INSTALLATION	1-6
THEFT GUARD INSTALLATION	1-10
MICROPHONE CONNECTIONS	1-11
OPERATION	1-12
SECTION 2 – TECHNICAL NOTES	
BLOCK DIAGRAM	2-1
CIRCUIT INFORMATION	2-2
FUNCTIONS OF CIRCUIT COMPONENTS	2-2
CIRCUIT DESCRIPTION	2-5
CRYSTAL DATA	2-8
FREQUENCY RELATIONSHIPS	2-9
HORN RELAY UNIT FHR-1 DIAGRAM	2-10
AC POWER SUPPLY FP-8 DIAGRAM	2-10
PROGRAMMING THE FTC-2640	2-11
BAND TABLE	2-27
SECTION 3 – SERVICING	
OUTER COVER/FRONT PANEL REMOVAL	3-1
MAIN BOARD PARTS LAYOUT	3-3
POWER AMP UNIT PARTS LAYOUT	3-5
DIODE MATRIX BOARD PARTS LAYOUT	3-6
LED BOARD PARTS LAYOUT	3-7
RELAY BOARD PARTS LAYOUT	3-7
TRANSISTOR & IC PINOUTS	3-8
TRANSMITTER SECTION LEVEL DIAGRAM	3-9
RECEIVER SECTION LEVEL DIAGRAM	3-10
VOLTAGE CHART	3-11
SOLDERING AND DESOLDERING TECHNIQUE	3-12
FAULT LOCALIZATION	3-14
MAINTENANCE AND SERVICING	3-15

For Service Manuals Contact
MAURITRON TECHNICAL SERVICES
8 Cherry Tree Rd, Chinnor
Oxon OX9 4QY
Tel:- 01844-351694 Fax:- 01844-352554
Email:- enquiries@mauritron.co.uk

	(Page)
ALIGNMENT	3-16
PLL CIRCUITS	3-17
TRANSMITTER CIRCUITS	3-17
RECEIVER CIRCUITS	3-23
TROUBLESHOOTING	3-26
PLL	3-26
RECEIVER	3-27
TRANSMITTER	3-30

SECTION 4 – REPAIR PARTS

PARTS LIST	4-1
------------------	-----

For Service Manuals Contact
MAURITRON TECHNICAL SERVICES
8 Cherry Tree Rd, Chinnor
Oxon OX9 4QY
Tel:- 01844-351694 Fax:- 01844-352554
Email:- enquiries@mauritron.co.uk

YAESU FTC-2640 VHF LAND MOBILE TRANSCEIVER

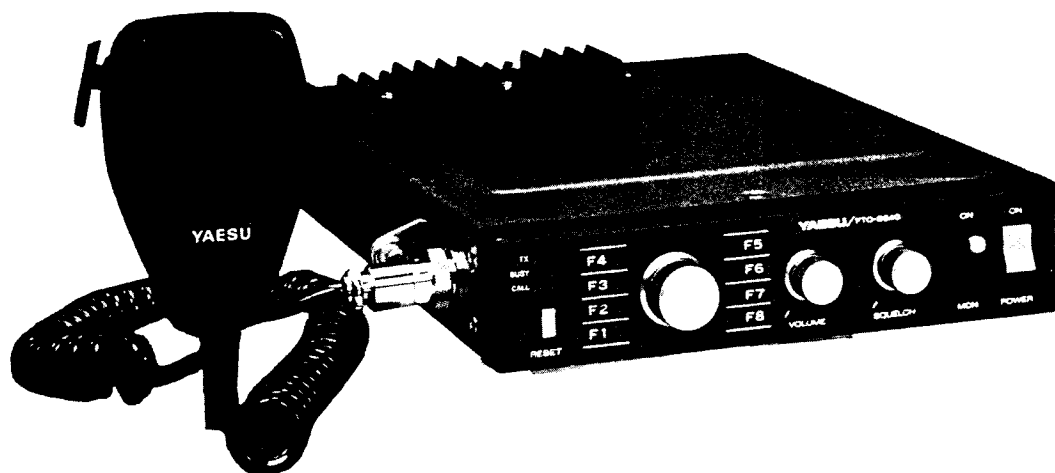

For Service Manuals Contact
MAURITRON TECHNICAL SERVICES
 8 Cherry Tree Rd, Chinnor
 Oxon OX9 4QY
 Tel:- 01844-351694 Fax:- 01844-352554
 Email:- enquiries@mauritron.co.uk

GENERAL DESCRIPTION

The FTC-2640 is a compact, high-performance VHF FM transceiver for land mobile applications. Fully solid state, this transceiver provides operation within a 10 MHz range in the 134 – 174 MHz land mobile band. The transmitter section of the FTC-2640 puts out 40 watts. The receiver section provides high sensitivity, yet excellent rejection of intermodulation and cross modulation products.

Designed for use in a variety of land mobile applications, this transceiver is packaged in a heavy gauge metal case, thus minimizing the chance of damage from shock or vibration. The FTC-2640 is also protected against damage from high antenna SWR.

The FTC-2640 is supplied with all mounting hardware, cables, and connectors required for mobile installation.

PERFORMANCE SPECIFICATIONS

GENERAL

Frequency range:

- 8 desired spot frequencies within a 10 MHz spread within the range 134 – 174 MHz (5 Bands)
- (A) 134 – 144 MHz, (*134.3 – 144.3 MHz)
 - (B) 144 – 154 MHz, (*144.3 – 154.3 MHz)
 - (C) 154 – 164 MHz, (*154.3 – 164.3 MHz)
 - (D) 164 – 174 MHz, (*164.3 – 174.3 MHz)
 - (E) 150 – 160 MHz (*150.3 – 160.3 MHz)

Oscillation system:

PLL control

External connections:

Push-to-talk microphone and mounting bracket furnished. External antenna jack and power supply connections in rear.

Weight:

Approx. 2.0 kg

Dimensions:

40(50)mm (H) x 180(212)mm (W) x 252(295)mm (D)
(larger dimensions include heatsinks, knobs and jacks.)

Power requirements:

DC 13.6 volts (negative ground)

Power consumption (at 13.6 V)

Standby: Less than 0.3 A
Receive: Less than 1.0 A
@ 1.5 W audio output
Transmit: 10 A

Number of channels:

8

TRANSMITTER

Power output:

40 watts

Frequency stability:

Better than ± 5 ppm

Modulation type:

16F3 (phase modulation)
(*11F3)

Transmitter audio deviation:

± 5 kHz
(* ± 2.5 kHz)

Audio response:

+1, -3 dB/octave pre-emphasis characteristic from 300 Hz to 2500 Hz.

FM noise:

-40 dB @ ± 3 kHz deviation w/1 kHz modulation.
(* -34 dB @ ± 1.5 kHz deviation w/1 kHz modulation)

Spurious emissions:

At least 60 dB below carrier.

AF distortion:

10% or less @ 1 kHz, ± 3 kHz deviation.
(*10% or less @ 1 kHz, ± 1.5 kHz deviation)

Antenna impedance:

50 ohms

Microphone type:

Low impedance (600 ohm) dynamic

RECEIVER

Frequency stability:

Better than ± 5 ppm

Sensitivity:

Better than $0.5 \mu\text{V}$ for 20 dB noise quieting
Better than $0.35 \mu\text{V}$ for 12 dB SINAD

Adjacent channel selectivity:

Better than -70 dB.

Image rejection:

Better than -80 dB.

Intermodulation:

Better than -70 dB.

Squelch sensitivity:

$0.2 \mu\text{V}$.

AF output:

1.5 watts @ 10% THD (8 ohms)
3 watts for External Speaker @ 10% THD (4 ohms)

Specifications subject to change without notice or obligation.

* 12.5 kHz/step model

For Service Manuals Contact
MAURITRON TECHNICAL SERVICES
8 Cherry Tree Rd, Chinnor
Oxon OX9 4QY
Tel: 01844-351694 Fax: 01844-352554
Email: enquiries@mauritron.co.uk

SEMICONDUCTORS

ICs

AN315	1
HD74LS02AP	1
HD74LS74AP	1
MB3756	1
MC14504B	1
MC14568B	1
MLM2902	2
TC9122P	2
μ PB551C (* μ PB555C)	1
μ PC577H	1
μ PC14305	1

Transistors

2SA628A(2SB856B)	1
2SC458B	5
2SC460B	7
2SC535B	8
2SC1209D	1
2SC1906	3
2SC2026	1
2SC2053	1
2SC2538	1
2SC2539	1
2SC2630	1

Varactor diodes

1T25	13
FC52M	1

Light emitting diodes

LN224RP	2
LN324GP	1
LN322GP	8

Zener diode

WZ071	1
-------	---

FETs

2SK168D	1
3SK51-03	4
3SK59	1
3SK60	2

* 12.5 kHz/step model

Silicon diodes

1S1555	20
1SS97	3
V06C	1
15FD11	1

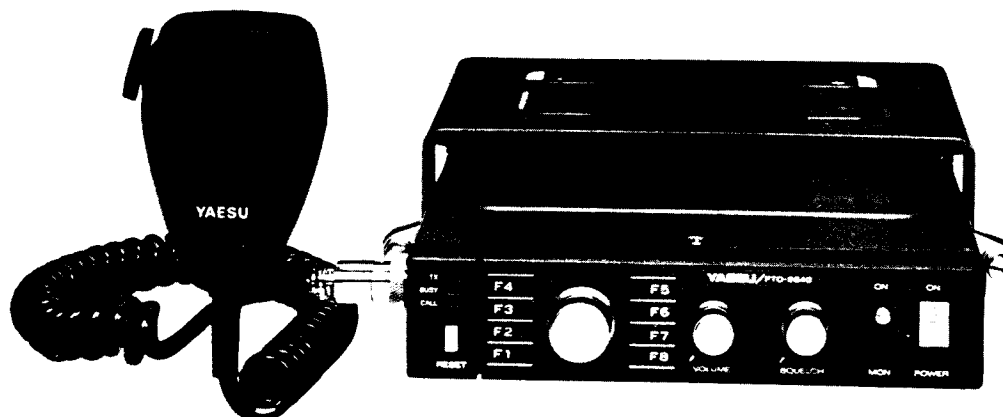

For Service Manuals Contact
MAURITRON TECHNICAL SERVICES
 8 Cherry Tree Rd, Chinnor
 Oxon OX9 4QY
 Tel:- 01844-351694 Fax:- 01844-352554
 Email:- enquiries@mauritron.co.uk

FRONT PANEL CONTROLS AND SWITCHES

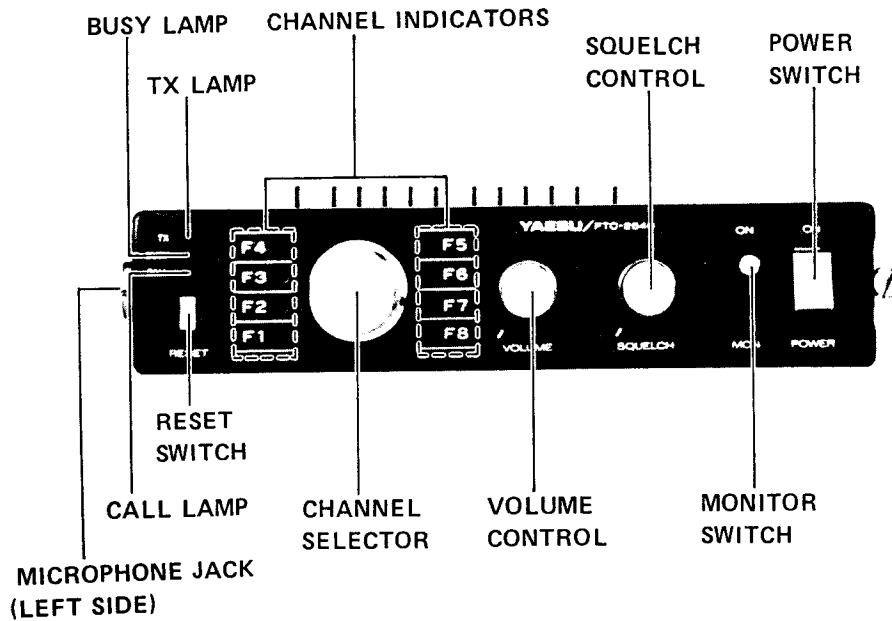

(1) MICROPHONE JACK

This six-pin jack accepts the microphone input, as well as push-to-talk (PTT) control.

(2) VOLUME

The volume control varies the receiver audio output level. Clockwise rotation increases the volume.

(3) POWER

This is the main ON/OFF switch for the transceiver. When the switch is turned on, one channel indicator (LED) will become illuminated.

(4) SQUELCH

The squelch control quiets the audio output of the transceiver until a signal is received.

(5) CHANNEL

The 8-position channel selector switch selects the desired channel.

(6) CHANNEL INDICATORS (F1 – F8)

One of these LEDs lights up indicating the channel selected.

(7) INDICATOR LAMPS

- TX: This LED lights up during transmission.
- BUSY: This LED lights up when the channel is occupied.
- CALL: This LED lights up when the selective calling code for the transceiver is detected by the Two-Tone Decoder (optional unit).

(8) RESET

Press this button to reactivate the optional Two-Tone Decoder after responding to a call.

(9) MON ON/OFF

This switch allows monitoring during CTCSS operation.

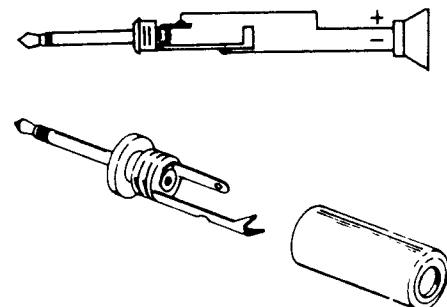

Speaker Plug

For Service Manuals Contact
MAURITRON TECHNICAL SERVICES
 8 Cherry Tree Rd, Chinnor
 Oxon OX9 4QY
 Tel:- 01844-351694 Fax:- 01844-352554
 Email:- enquiries@mauritron.co.uk

REAR APRON CONNECTIONS

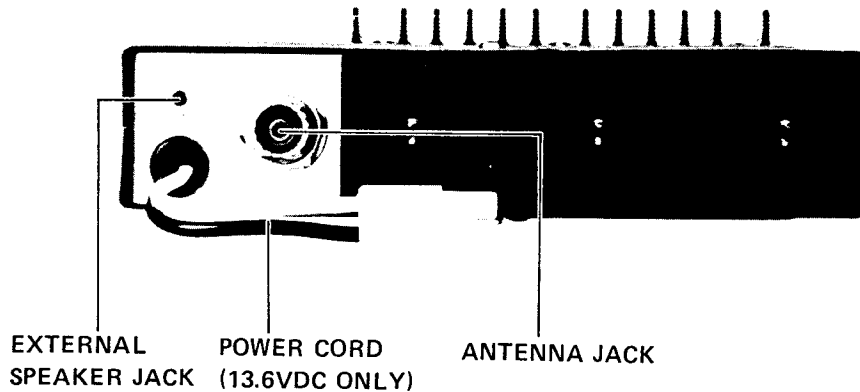

(1) ANT

This is an SO-239 coaxial receptacle for making connection to the antenna.

(2) EXT SP

An external 4 or 8 ohm speaker may be connected at this point. Inserting a plug into this jack automatically disables the internal speaker.

(3) POWER CABLE/CONNECTOR

The main DC power cord from the power source is inserted in this sub-connector. Never apply AC voltage or any power voltage other than the type specified.

WARNING

DO NOT CONNECT AC POWER TO THE DC POWER RECEPTACLE. REPLACE FUSES ONLY WITH A 15 AMP FUSE. FAILURE TO OBSERVE THESE WARNINGS WILL VOID THE WARRANTY.

For Service Manuals Contact
MAURITRON TECHNICAL SERVICES
 8 Cherry Tree Rd, Chinnor
 Oxon OX9 4QY
 Tel:- 01844-351694 Fax:- 01844-352554
 Email:- enquiries@mauritron.co.uk

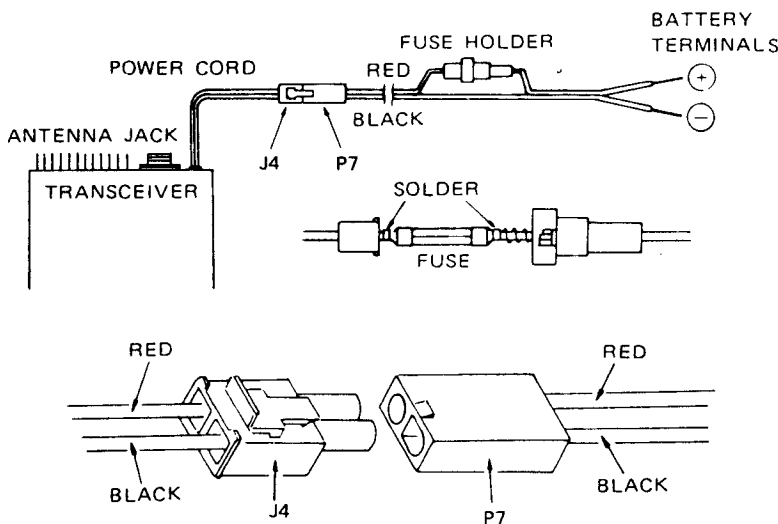

POWER CORD DIAGRAM

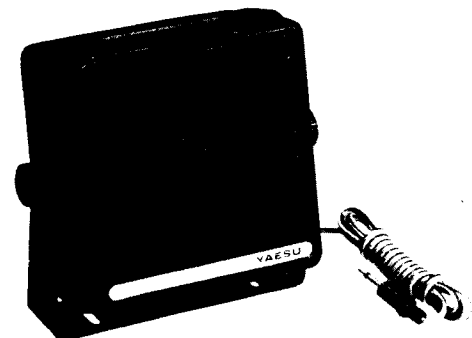

FSP-1/FSP-2
 EXTERNAL SPEAKER

INSTALLATION

The FTC-2640 is designed primarily for mobile installation, requiring only an antenna and a 13.6 VDC power source for operation. The transceiver has been pretuned at the factory, and no adjustment is required for operation into a 50 ohm load.

For mobile installations, three basic factors must be considered. These are: the antenna system and feedline; the physical location of the transceiver; and the power connections. We will consider each of these individually in the following sections.

ANTENNA CONSIDERATIONS

The FTC-2640 is designed for operation into a 50 ohm antenna system. While variations of a few ohms from this figure are of no consequence, the automatic final amplifier protection circuitry will reduce the power output if the impedance presented to the antenna jack is below 25 ohms or above 100 ohms.

The antenna should be located away from the automobile engine, if possible, in order to avoid unnecessary noise pickup. Ideal locations are the center of the car roof or the center of the trunk lid. Where ground connections are made, they should be scraped clean of all paint and corrosion, so as to ensure adequate contact. Lossy ground connections can have seriously detrimental effects on the antenna system impedance and radiation pattern.

To minimize losses in the antenna system, the shortest possible length of coaxial cable should be used. For mobile installations, type RG-58A/U is suitable because of its small size. For base stations, however, larger sizes are to be preferred. Base station systems requiring more than 25 feet of coaxial cable should utilize type RG8A/U, and extremely long runs of many hundreds of feet generally require the use of type RG-17A/U, aluminum-jacketed "foamflex" coax, or air-dielectric "heliac" coax.

The antenna should be tuned for the center of the 10 MHz working band of the transceiver. To check the SWR, install a 50 ohm SWR meter between the transceiver antenna jack and the antenna. Place the selector switch into the FORWARD position on the meter, and transmit briefly (make certain that the channel is clear first). Rotate the FORWARD SET or SWR SET control for a full scale reading while transmitting. Now switch to REFLECTED on the meter, and read the SWR. If it is below 1.5, you are in good shape. If not, check the high and low band edges of the 10 MHz range of the transceiver to see if the antenna is detuned. If the SWR is very high (more than 3 : 1), there may be trouble in the coaxial cable. Check the SWR with the meter installed **at the antenna**, or test the coax by replacement with cable known to be good.

For Service Manuals Contact
MAURITRON TECHNICAL SERVICES
 8 Cherry Tree Rd, Chinnor
 Oxon OX9 4QY
 Tel:- 01844-351694 Fax:- 01844-352554
 Email:- enquiries@mauritron.co.uk

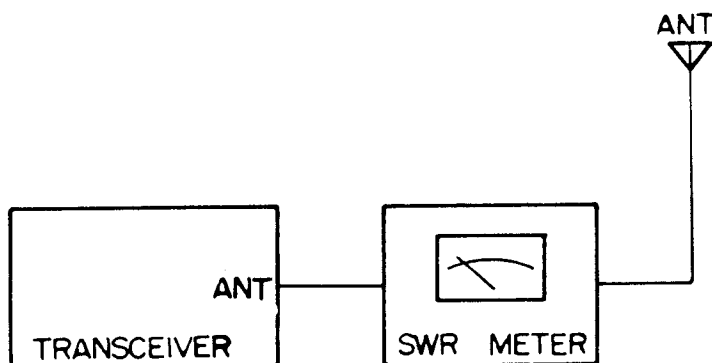

WHILE TRANSMITTING:

1. SWITCH TO FORWARD
2. SET METER FOR FULL SCALE
3. SWITCH TO REFLECTED
4. READ SWR ON METER.

TYPICAL SWR TEST SETUP

Figure 1-1

PHYSICAL LOCATION OF TRANSCEIVER

The FTC-2640 may be installed at any angle desired without loss of performance. Typical locations are atop the transmission tunnel, below or in the dash board, or overhead (in a truck, etc.).

When considering a possible location for the transceiver, several factors must be considered. First, there must be room for the transceiver cables, the microphone, and heat sink. We recommend that several inches of space be available around the heat sink to allow free air circulation. Also, we recommend that the transceiver not be located directly in the path of the output vent from the car heater.

Another consideration is the routing of cables to the desired installation location. If the power cable to the battery or the coaxial cable to the antenna must be extended greatly in order to meet aesthetic considerations, the resulting increased losses may degrade performance. Fortunately, the common under-dash installation lends itself well to efficient performance, as the power cable can easily be fed through the fire wall.

One final consideration is safety. The transceiver and its microphone must never be installed in a position that may interfere with driver vision or operation of the vehicle. Be especially wary of stick shifts in compact cars, and allow plenty of room for unobstructed manipulation of the controls. The FTC-2640 is a very compact unit, so there is no reason ever to compromise safety during installation.

POWER CONNECTIONS

For mobile installation, direct connection to the battery is to be preferred. If power connections are made at the ignition switch, unnecessary noise pickup may occur. Also, if power is taken from the automobile lighting, cigarette lighter, or other circuits, the circuit line fuse may blow because of insufficient capacity. A fuse (15 amp) is located in the DC power cord for the transceiver, protecting its circuitry.

The power connection procedure is detailed below. Once the power connections are made, but before the power cord is connected to the transceiver, you should check the battery charging voltage with the engine running fast enough for the car ammeter to show a charge. If the voltage exceeds 15 volts, the car voltage regulator must be adjusted to limit the maximum voltage to less than 15 volts.

CAUTION

Be certain to observe proper polarity in the power cord when making connections to the vehicle battery.

CAUTION

Permanent damage may result if reversed polarity supply voltage is applied to this transceiver. Our warranty does not cover damage caused by reversed power supply connections.

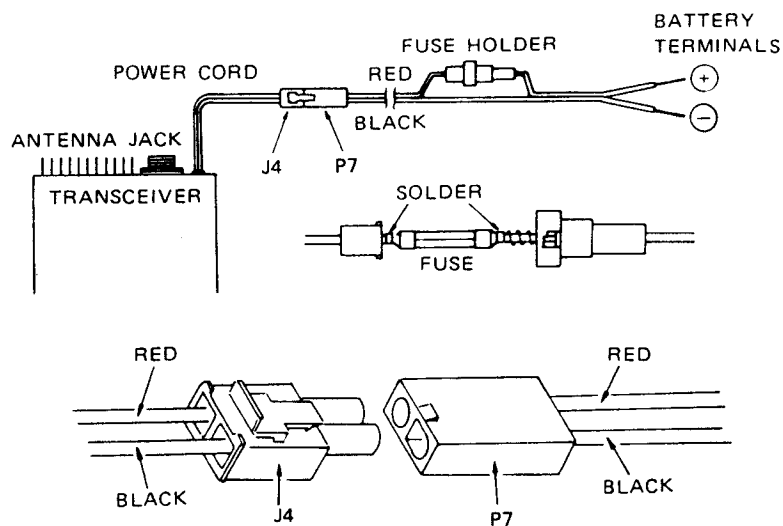

POWER CORD DIAGRAM

For Service Manuals Contact
MAURITRON TECHNICAL SERVICES
 8 Cherry Tree Rd, Chinnor
 Oxon OX9 4QY
 Tel: 01844-351694 Fax: 01844-352554
 Email: enquiries@mauritron.co.uk

INSTALLATION STEP-BY-STEP OUTLINE

1. Determine the optimum location for the transceiver, making certain that there is sufficient space for the transceiver, its cables and switches, and the microphone. Leave several inches of space around the heat sink, to permit free air flow.
2. A mounting bracket FMB-4-1 is supplied with the transceiver. Use the bracket as a template for positioning the mounting holes. Use a 3/16" diameter bit for drilling these holes, allowing clearance for the transceiver and all accessories and cables. Secure the mounting bracket with the screws, washers, and nuts supplied, as shown in the drawing.
3. Ease the transceiver into the guide rail, and slide it into the desired position. Tighten the knobs on the outside of the mounting bracket to secure the transceiver.
The optional mounting bracket key lock is available from your Yaesu dealer.
4. Confirm that the installation does not obstruct normal, safe operation of the vehicle.
5. Route the transceiver power cable through the fire wall to the battery. Avoid proximity to ignition cables if at all possible. Lay out the power cable so as not to have it interfere with the normal operation of the fan belt or other engine components.
6. Connect the RED battery lead to the POSITIVE (+) side of the battery. Connect the BLACK lead to the NEGATIVE (-) side of the battery.
7. If the optional FSP-1 (8 ohm) or FSP-2 (4 ohm) external speaker is to be installed, it may be connected to the rear panel SP jack. The speaker can then be mounted wherever convenient for the operator. Insertion of the speaker plug into the jack on the rear apron automatically disables the internal speaker of the transceiver.

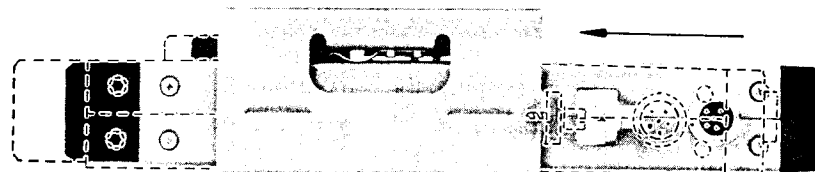
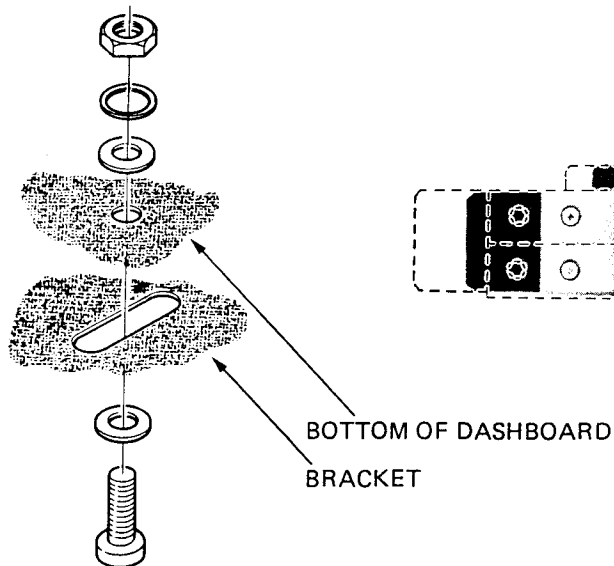

FMB-4-1

For Service Manuals Contact
MAURITRON TECHNICAL SERVICES
 8 Cherry Tree Rd, Chinnor
 Oxon OX9 4QY
 Tel: 01844-351694 Fax: 01844-352554
 Email: enquiries@mauritron.co.uk

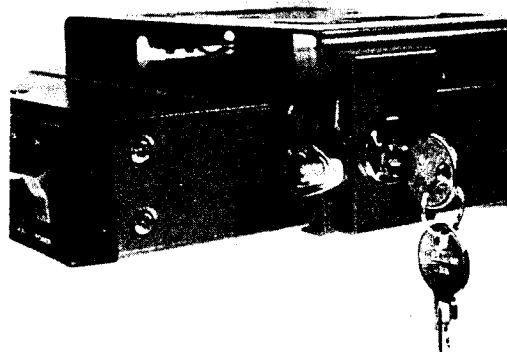
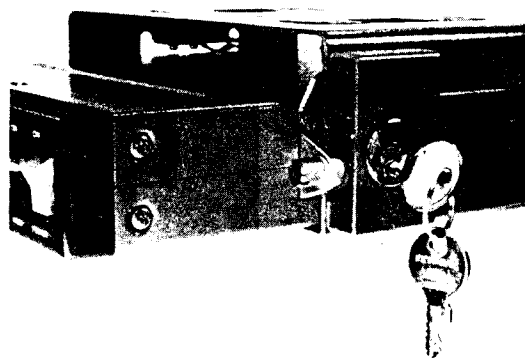

FMB-4 (With Optional Key Lock)

BASE STATION INSTALLATION

For base station installations, the FP-8 AC Power Supply option offers a convenient means of providing the required 13.6 VDC for the FTC-2640 transceiver.

Before commencing operation with the FP-8, be absolutely certain that the power transformer primary has been wired correctly for the local line voltage in your area. The FP-8 is marketed throughout the world, and a unit that you receive from a customer who recently has been abroad may be wired for a different voltage. Operation of the FP-8 from an improper supply voltage will void all warranties on the set.

Connect the RED power lead to the POSITIVE (+) terminal and connect the BLACK power lead to the NEGATIVE (-) terminal on the FP-8 rear apron.

CAUTION

Our warranty does not cover damage caused by improper power supply connections, nor damage caused by the use of an incorrect fuse.

Connect the four pin plug on the cable from the FP-8 to J₁ on the FP-8 rear apron, and plug the FP-8 AC cable into the wall outlet. Now turn the FP-8 switch ON, and then turn the transceiver power switch ON. The radio will now be ready for operation, if you have the antenna and microphone connected.

The FP-8 contains a quality speaker for base station installation. Connect the miniature phone plug from the FP-8 to the SP jack on the rear apron of the transceiver.

NOTICE

The four pin plug must be connected to the J₁ on the FP-8 rear apron. Pin 1 and pin 2 of the four pin plug are used for the AC switching function.

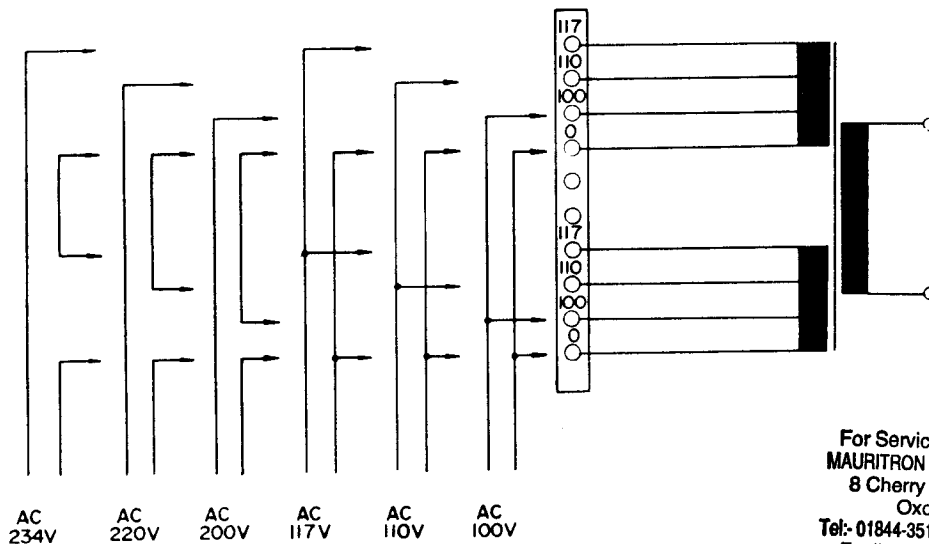

POWER TRANSFORMER PRIMARY CONNECTIONS

For Service Manuals Contact
MAURITRON TECHNICAL SERVICES
 8 Cherry Tree Rd, Chinnor
 Oxon OX9 4QY
 Tel: 01844-351694 Fax: 01844-352554
 Email: enquiries@mauritron.co.uk

THEFT GUARD INSTALLATION USING FHR-1

The Theft Guard feature of the FHR-1 Horn Relay box can be an effective deterrent to burglary. When the connection from the FHR-1 box to the FTC-2640 is interrupted, the horn will begin blaring on and off, and further tampering with the car will probably be discouraged.

In order to make it difficult for a thief to disable the Theft Guard, we recommend that the FHR-1 be installed under the hood of the automobile in a fairly dry location. Alternatively, it may be installed in some inaccessible location under the dash. The only time that ON/OFF switching should be needed is in the event of an attempted burglary, as the current drain is negligible in the standby mode. To quiet the horn, turn the FHR-1 power switch to OFF.

Installation Procedure:

- (1) Refer to Figure 1-2, and mount the FHR-1 box in the desired location. The unit is not waterproof, so a position not exposed to moisture is recommended.
- (2) Refer to the interconnection diagram (Page 2-10), and hook up the wires as shown. The two heavy red wires (bare ends, with no connector) should be wired in parallel with the main steering wheel horn switch of the car. The three leads from the molded connector are connected as follows: the white lead goes to the FTC-2640 HORN RELAY terminal (Figure 1-3); the red lead goes to an auxiliary post on the fuse block, if one is available (10 amp fuse is OK); the black lead goes to ground.
- (3) Inside the FHR-1 are two miniature potentiometers, shown in Figure 1-4. VR₁₀₁ controls the ON time of the beeping horn; while VR₁₀₂ controls the OFF time. Either control provides an adjustment range of 2 to 25 seconds in the on and off times.
- (4) The operator should be educated in the importance of being able to turn off the horn relay quickly, so as to minimize disturbance to others. Also discuss with the operator the importance of maintaining good connections to the HORN RELAY jack, etc., so as not to induce false triggering of the horn.

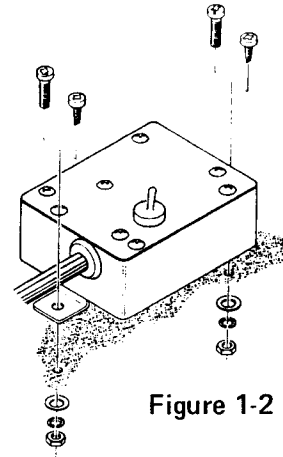

Figure 1-2

For Service Manuals Contact
MAURITRON TECHNICAL SERVICES
 8 Cherry Tree Rd, Chinnor
 Oxon OX9 4QY
 Tel: 01844-351694 Fax: 01844-352554
 Email: enquiries@mauritron.co.uk

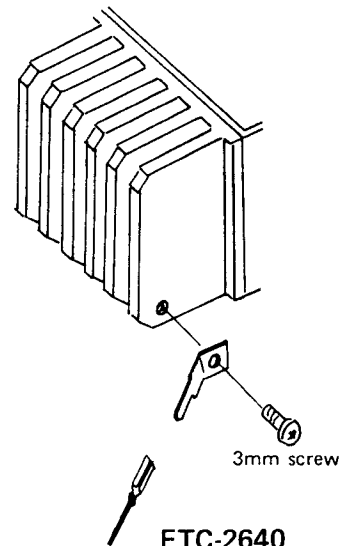

Figure 1-3

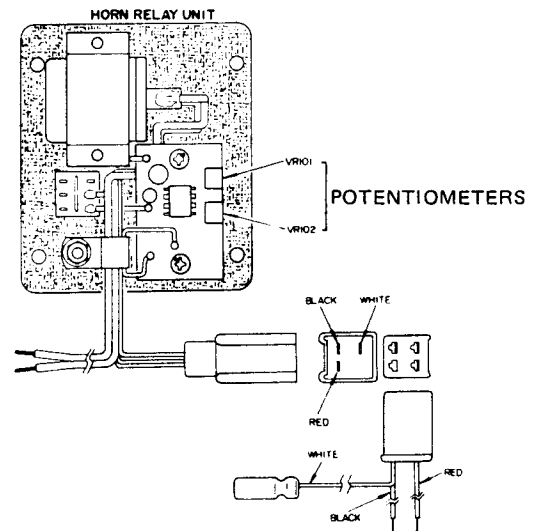
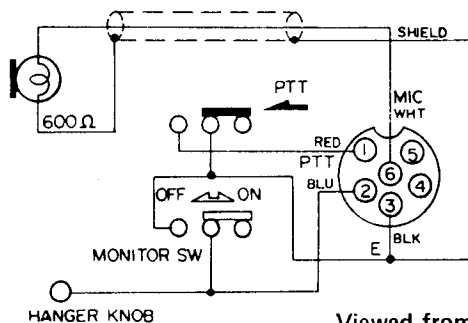
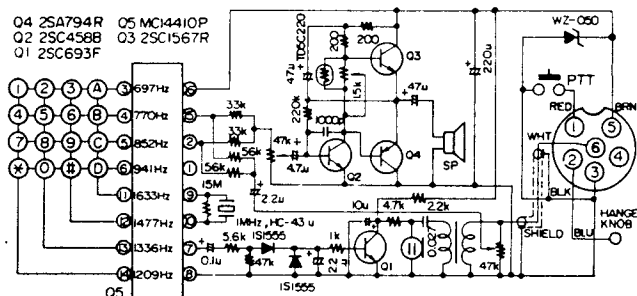

Figure 1-4

MICROPHONE CONNECTIONS



Viewed from "B" side
YM-31 MICROPHONE CONNECTIONS



Viewed from "B" side
YM-28 MICROPHONE CONNECTIONS

For Service Manuals Contact
MAURITRON TECHNICAL SERVICES
8 Cherry Tree Rd, Chinnor
Oxon OX9 4QY
Tel:- 01844-351694 Fax:- 01844-352554
Email:- enquiries@mauritron.co.uk

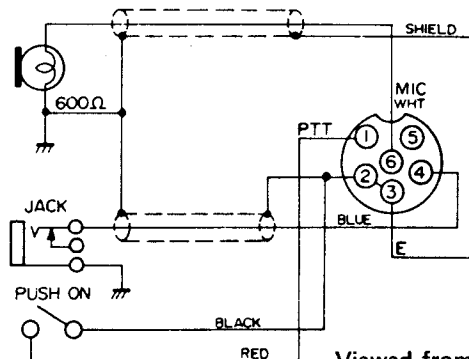

Viewed from "B" side
YM-33 MICROPHONE CONNECTIONS

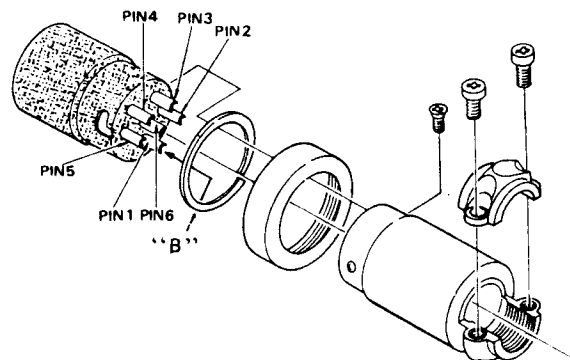

OPERATION

Operation of the FTC-2640 is extremely straightforward. Before commencing operation, confirm that power supply connections have been correctly made, and that a 50 ohm antenna is connected to the antenna jack.

- (1) Place the POWER switch in the ON position. The channel indicator will become illuminated.
- (2) Set the CHANNEL selector to the desired channel.
- (3) Rotate the SQUELCH control fully counter-clockwise.
- (4) Adjust the VOLUME control for a normal listening level on the background noise or incoming signal.
- (5) When the channel is clear, rotate the SQUELCH control carefully in a clockwise direction, to the point where the background noise is just silenced. If you go much beyond the point where the noise just disappears the receiver will not respond to weak signals.
- (6) After setting the receiver controls and selecting the proper channel, depress the microphone push-to-talk switch to activate the transmitter. Hold the microphone a short distance from your mouth, and speak in a clear normal voice across the face of the microphone (sideways).
- (7) When the optional tone squelch unit is installed and tone squelch operation is desired, a subaudible tone will be superimposed on the output signal when transmitting. On receive, when the MON switch is in the OFF position, a similar subaudible tone will be required to trip the receiver squelch. If a station is using the channel but is not using a subaudible tone generator, the BUSY lamp will light up, alerting the operator to the fact that the channel is in use.

For Service Manuals Contact
MAURITRON TECHNICAL SERVICES
8 Cherry Tree Rd, Chinnor
Oxon OX9 4QY
Tel:- 01844-351694 Fax:- 01844-352554
Email:- enquiries@mauritron.co.uk

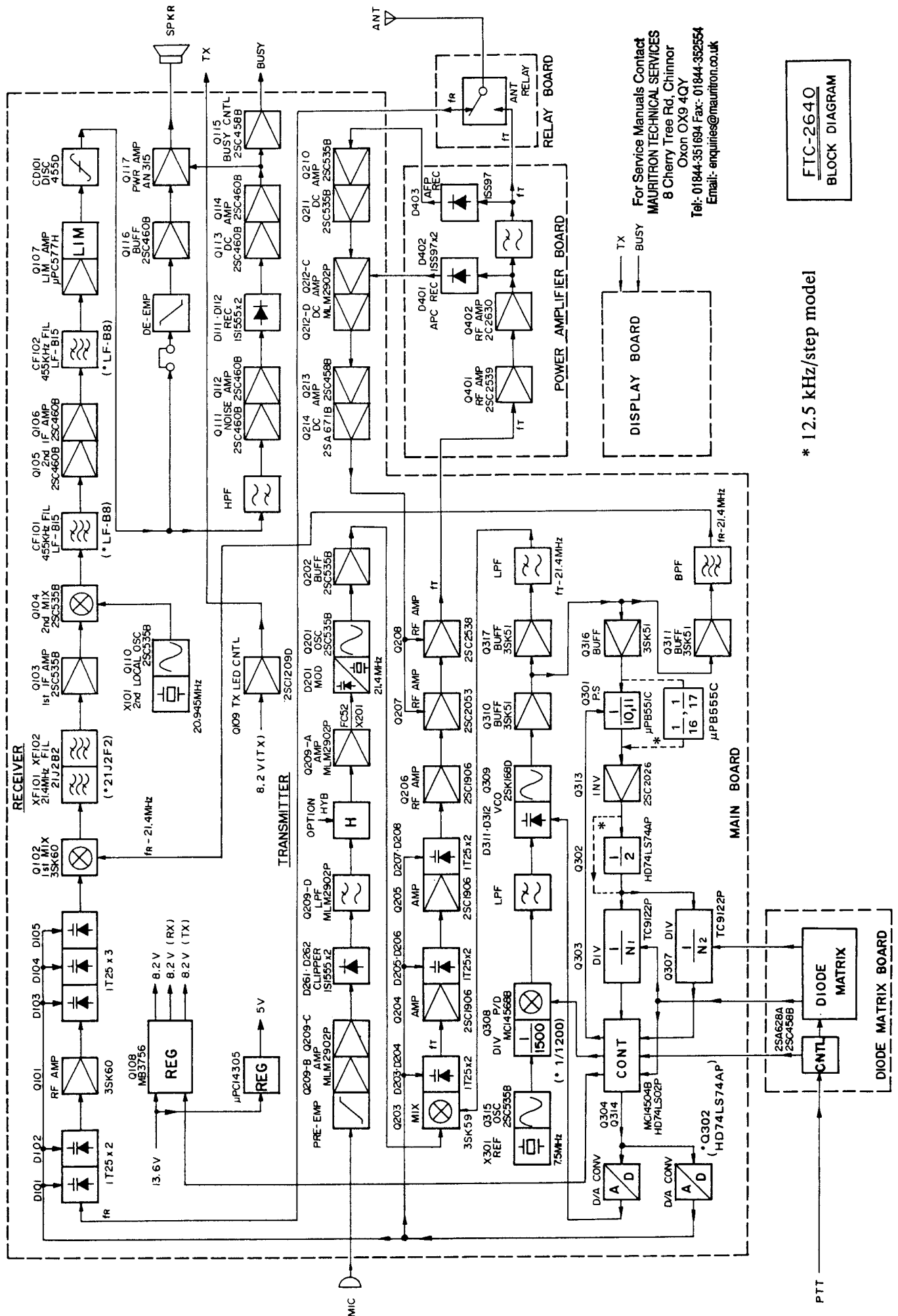

For Service Manuals Contact
MAURITRON TECHNICAL SERVICES
 8 Cherry Tree Rd, Chinnor
 Oxon OX9 4QY
 Tel: 01844-351694 Fax: 01844-352554
 Email: enquiries@mauritron.co.uk

FTC-2640
 BLOCK DIAGRAM

* 12.5 kHz/step model

CIRCUIT INFORMATION

The block diagram and circuit description to follow will provide you with a better understanding of this transceiver. Please refer to the schematic diagram for specific circuit details.

PARTS DESIGNATIONS ON CIRCUIT BOARDS

Each circuit board has a code number assigned to it, and each part within the transceiver has a part number assigned to it (e.g. Q₁₀₁).

Part numbers 01–99 (e.g. R₁₂) are located on the main chassis. Other parts, located on the circuit boards, are assigned a three or four digit part number; the last two figures represent the part number for the particular board, while the first one or two digits are the code number for that board.

Thus, Q₁₀₁ is transistor number 01, located on circuit board number 1, which is the RX Unit. Refer to the accompanying chart for a tabulation of the code numbers assigned to the FTC-2640 circuit boards.

Please note that the designation “Q” is applied to transistors as well as to integrated circuits. The “U” nomenclature for IC’s is not used in Yaesu diagrams.

Code #	Unit	Board Designation
1	RX circuit	} PB-2330A
2	TX circuit	
3	PLL circuit	
4	POWER AMPLIFIER	PB-2332
5	DIODE MATRIX BOARD	PB-2333
6	LED BOARD	PB-2334
7	RELAY BOARD	PB-2331

For Service Manuals Contact
MAURITRON TECHNICAL SERVICES
 8 Cherry Tree Rd, Chinnor
 Oxon OX9 4QY
 Tel: 01844-351694 Fax: 01844-352554
 Email: enquiries@mauritron.co.uk

FUNCTIONS OF CIRCUIT COMPONENTS

Part No.	Device	Type	Function
Q101	3SK60	Dual Gate MOSFET	RX RF Amplifier
102	"	"	RX 1st Mixer
103	2SC535B	Transistor	RX 1st IF Amplifier
104	"	"	RX 2nd Mixer
105	2SC460B	"	RX 2nd IF Amplifier
106	"	"	"
107	μPC577H	IC	"
108	MB3756	"	DC Limiter Regulator
109	2SC1209D	Transistor	Relay Driver
110	2SC535B	"	RX 2nd Oscillator
111	2SC460B	"	RX Squelch Amplifier
112	"	"	"
113	"	"	"
114	"	"	"
115	2SC458B	"	RX Busy LED Driver
116	2SC460B	"	RX Audio Buffer
117	AN315	IC	RX Audio Amplifier

Part No.	Device	Type	Function
Q201	2SC535B	Transistor	TX Modulation Oscillator
202	"	"	TX Buffer
203	3SK59	Dual Gate MOSFET	TX Mixer
204	2SC1906	Transistor	TX Amplifier
205	"	"	"
206	"	"	TX RF Amplifier
207	2SC2053	"	TX RF Amplifier
208	2SC2538	"	"
209	MLM2902P	IC	TX Microphone Amplifier
210	2SC535B	Transistor	AFP DC Amplifier
211	"	"	"
212	MLM2902P	IC	Differential Amplifier
213	2SC458B	Transistor	Power Control DC Amplifier
214	2SB856B	"	"
Q301	μ PB551C (* μ PB555C)	IC	PLL Prescaler
302	HD74LS74AP	"	PLL D Flip-Flop
303	TC9122P	"	PLL Divider
304	HD74LS02P	"	PLL Quad 2-input NOR Gate
305	2SC458B	Transistor	TX Control
306	"	"	"
307	TC9122P	IC	PLL Divider
308	MC14568B	"	PLL Phase Comparator
309	2SK168D	Junction FET	PLL VCO
310	3SK51	Dual Gate MOSFET	PLL VCO Buffer
311	"	"	PLL Output Buffer (RX)
312	μ PC14305	IC	DC Regulator
313	2SC2026	Transistor	PLL Inverter
314	MC14504B	IC	PLL Level Shifter
315	2SC535B	Transistor	PLL Reference Oscillator
316	3SK51-03	Dual Gate MOSFET	PLL Buffer
317	"	"	PLL Output Buffer (TX)
Q401	2SC2539	Transistor	TX RF Amplifier
402	2SC2630	"	"
Q501	2SC458B	Transistor	Diode Matrix Control
502	2SA628A	"	"
D101	1T25	Varactor Diode	RX Auto Tune
102	"	"	"
103	"	"	"
104	"	"	"
105	"	"	"
106	1S1555	Si Diode	Discriminator
107	"	"	"
111	"	"	Noise Rectifier
112	"	"	"
113	"	"	Switch
114	"	"	"
115	"	"	"
116	"	"	"

* 12.5 kHz/step model

Part No.	Device	Type	Function
D201	FC52M	Varactor Diode	TX Modulator
202	1S1555	Si Diode	Switch
203-208	1T25	Varactor Diode	TX Auto Tune
261	1S1555	Si Diode	Modulation Limiter
262	"	"	"
D301	1S1555	Si Diode	Switch
302	"	"	"
303	"	"	"
304	"	"	"
305	"	"	"
306	"	"	"
307	"	"	"
308	WZ071	Zener Diode	DC Regulator
309	1S1555	Si Diode	"
311	1T25	Varactor Diode	PLL OSC
312	"	"	"
313	1S1555	Si Diode	Switch
D401	1SS97	Schottky Barrier Diode	APC Rectifier
402	"	"	"
403	"	"	AFP "
D501		Diode Array	Diode Matrix
D601	LN224RP	LED	Call Indicator
602	LN324GP	"	Busy Indicator
603	LN224RP	"	TX Indicator
604-611	LN322GP	"	CH Indicator
D701	V06C	Si Diode	Surge Protector
702	15FD11	"	Reversed Polarity Supply Protector
X101		Crystal	RX 2nd local Osc.
201		"	TX Modulation Osc.
301		"	PLL Reference Osc.
XF101	21J2B2 (*21J2F2)	Crystal Filter	RX 1st IF Filter
102	"	"	"
CF101	LF-B15 (*LF-B8)	Ceramic Filter	RX 2nd IF Filter
102	"	"	"
CD101	455D	Discriminator	Ceramic Discriminator

* 12.5 kHz/step model

For Service Manuals Contact
MAURITRON TECHNICAL SERVICES
 8 Cherry Tree Rd, Chinnor
 Oxon OX9 4QY
 Tel: 01844-351694 Fax: 01844-352554
 Email: enquiries@mauritron.co.uk

CIRCUIT DESCRIPTION

RECEIVER

The incoming RF signal from the antenna connector is fed through an antenna relay to the RF amplifier, Q₁₀₁ (3SK60). The signal passes through input and output auto-tune filters to eliminate unwanted signals which may cause intermodulation and cross-modulation. The center frequencies of these filters are automatically adjusted by a control preset voltage in 1 MHz steps from the PLL circuit. After amplification, the signal is fed to 1st mixer Q₁₀₂ (3SK60), where it is mixed with the first local signal delivered from the PLL local oscillator, resulting in a 21.4 MHz first IF signal. This signal passes through monolithic crystal filters XF₁₀₁ and XF₁₀₂ to amplifier Q₁₀₃ (2SC535B), and is then fed to 2nd mixer Q₁₀₄ (2SC535B) where it is mixed with a 20.945 MHz second local signal. As a result, the second IF of 455 kHz is obtained.

The 2nd local frequency of 20.945 MHz is generated by Q₁₁₀ (2SC535B) and fed to the second mixer. The 2nd IF signal is fed through a ceramic filter, CF₁₀₁, to 2nd IF amplifiers Q₁₀₅ and Q₁₀₆ (2SC460B), where the signal is amplified and again fed through a ceramic filter, CF₁₀₂, cutting off unwanted signals. This signal is then fed to limiter/amplifier IC Q₁₀₇ (μ PC577H), where the IF signal is amplified to a level sufficient to drive the discriminator. Amplitude variation of the IF signal is rejected by the limiter, and then the signal is fed to the discriminator consisting of ceramic discriminator elements CD₁₀₁, D₁₀₆ and D₁₀₇. From this circuit an audio output is provided in response to the corresponding frequency shift of the IF signal.

The audio output signal from the discriminator is fed to a notch filter to reject the 455 kHz signal on the audio output. The signal is then fed through pin 4 of J₁₀₁ to the tone squelch unit (optional). When the tone squelch unit is not installed, the signal is fed via jumper to the de-emphasis network consisting of R₁₄₀ and C₁₅₄. The de-emphasized audio output is fed through audio volume control VR₁ to audio buffer Q₁₁₆ (2SC460B), and then fed to audio power amplifier IC Q₁₁₇ (AN315), which delivers 1.5 watts of audio output power to the speaker.

The squelch circuit consists of noise amplifier Q₁₁₁ and Q₁₁₂ (2SC460B), and DC amplifier Q₁₁₃ and Q₁₁₄ (2SC460B). When no carrier is present in the 455 kHz IF signal, the high frequency noise present at the discriminator output is amplified by Q₁₁₁ and Q₁₁₂, and then detected by D₁₁₃ and D₁₁₄ (1S1555), producing a DC voltage. The voltage is amplified by Q₁₁₃ and Q₁₁₄ and fed to pin 10 of Q₁₁₇, cutting off the audio amplifier. A portion of the DC voltage from Q₁₁₄ is delivered to Q₁₁₅ (2SC458B), which turns the BUSY LED on when a carrier is present in the 455 kHz IF. When a carrier is present the noise is removed from the discriminator output, and the audio amplifier operates normally.

For Service Manuals Contact
MAURITRON TECHNICAL SERVICES
8 Cherry Tree Rd, Chinnor
Oxon OX9 4QY
Tel: 01844-351694 Fax: 01844-352554
Email: enquiries@mauritron.co.uk

TRANSMITTER

The speech input signal from the microphone passes through a pre-emphasis network consisting of C₂₆₃ and R₂₆₃. This signal is amplified by Q₂₀₉ (B) and Q₂₀₉ (C) (MLM2902P) and fed to the IDC (Instantaneous Deviation Control) circuit, which consists of R₂₆₈, R₂₆₉, R₂₇₀, D₂₆₁ and D₂₆₂ (1S1555). Here, the amplified speech signal is limited in amplitude so as not to produce over-deviation from the higher speech levels. Next, the signal passes through an active lowpass filter, Q₂₀₉ (D), and its associated circuits. Here, the frequency spectrum above the speech range is rejected. This signal is buffered by amplifier Q₂₀₉ (A) and delivered to the frequency modulator circuit.

The 21.4 MHz TX MOD/OSC circuit, Q₂₀₁ (2SC535B) and D₂₀₁ (FC52), modulates its oscillating frequency with the AF signal delivered from Q₂₀₉ (A), which is then amplified by buffer Q₂₀₂ (2SC535B) and fed to mixer Q₂₀₃ (3SK59). The signal is there mixed with the local signal delivered from the PLL local oscillator, and as a result, the output signal at the TX frequency is obtained. This heterodyned signal passes through a double auto-tune filter consisting of D₂₀₃ and D₂₀₄ (1T25) and associated circuits, resulting in rejection of unwanted spurious. The center frequency of this filter is varied to correspond with the operating frequency with the help of the auto-tune control voltage from the PLL circuit.

Next, this signal is amplified by two stages of amplifier/filter, Q₂₀₄ and Q₂₀₅ (2SC1906) and D₂₀₅ – D₂₀₈ (1T25), which also make up the other stage of the auto-tune filter, to reject spurious caused by mixer Q₂₀₃. Spurious products are thus suppressed more than 70 dB.

This signal is delivered to a pre-driver stage consisting of Q₂₀₆ (2SC1906), Q₂₀₇ (2SC2053) and Q₂₀₈ (2SC2538), where the clean low level TX signal is amplified to a level sufficient to drive the power amplifier.

The power amplifier unit is composed of two stages of transistors. The output from Q₂₀₈ is coupled through a matching network to the base of Q₄₀₁ (2SC2539) and then fed through another matching network to final amplifier Q₄₀₂ (2SC2630). Here, the signal is amplified up to 40 watts. It then passes through a low pass three-section pi filter, which reduces the harmonic spurious of the carrier signal more than 60 dB. Finally, the signal is fed through a directional coupler and the antenna relay to the antenna connector.

AUTOMATIC FINAL PROTECTION CIRCUIT

The reflected voltage when a load other than 50 ohms is connected to the ANT connector is sensed by the directional coupler and rectified by D₄₀₃ (1SS97). This provides a control voltage which is fed to the DC amplifier consisting of Q₂₁₀, Q₂₁₁ (2SC535B), Q₂₁₂ (D), Q₂₁₂ (C) (MLM2902P), Q₂₁₃ (2SC458B), and Q₂₁₄ (2SB856B). This signal reduces the VCC voltage fed to RF amplifier Q₂₀₇ and Q₂₀₈, thus reducing the drive level for the final amplifier to protect the transistors from high SWR load conditions at the ANT connector.

AUTOMATIC POWER CONTROL CIRCUIT

A portion of the RF signal from driver Q₄₀₂ is rectified by D₄₀₁ and D₄₀₂ (1SS97) and delivered to Q₂₁₂ (C), where the DC voltage controls the DC amplifier stage, thus reducing the VCC voltage to the pre-driver stage.

* 12.5 kHz/step model

DC VOLTAGE CHANGEOVER CIRCUIT

The PTT line from Q₃₀₄ (HD74LS02P) is fed to DC voltage control IC Q₁₀₈ (MB3756), which provides 8.2 volts for either the TX or RX circuits.

PLL LOCAL SIGNAL OSCILLATOR

The PLL local signal oscillator consists of a VCO (voltage controlled oscillator), a reference crystal oscillator, a programmable divider, a phase comparator and a lowpass filter, all of which work to generate the TX or RX frequency minus 21.4 MHz.

The VCO; Q₃₀₉ (2SK168D), D₃₁₁ and D₃₁₂ (1T25); generates the desired local signal. The oscillator frequency is controlled by varactor diode D₃₁₁, which varies the capacitance of the tuned circuit in accordance with the DC voltage supplied through a lowpass filter from phase comparator Q₃₀₈ (MC14568B). The center frequency of the VCO is preset by another varactor diode, D₃₁₂, whose control voltage is delivered in 1 MHz steps from the Digital-to-Analog converter. This Digital-to-Analog converter provides a preset voltage corresponding to the programmed data for the operating frequency.

The output from Q₃₀₉ is fed through buffer amplifiers Q₃₁₀ and Q₃₁₇ (3SK51-03) and a lowpass filter to TX mixer Q₂₀₃. A portion of the RF signal from Q₃₁₀ is fed to buffer amplifier Q₃₁₁ (3SK51-03), and then passes through a lowpass filter to RX 1st mixer Q₁₀₂.

Another portion of the RF signal from Q₃₁₀ is amplified by buffer Q₃₁₆ (3SK51-03) and fed to a programmable counter circuit, which consists of 10/11 (*16/17) prescaler Q₃₀₁ (μ PB555C) (* μ PB555C), inverter Q₃₁₃ (2SC2026), 1/2 divider Q₃₀₂ (HD74LS74AP), and programmable dividers Q₃₀₃ and Q₃₀₇ (TC9122P), where the VCO frequency is divided by the number programmed into the diode matrix, and thus produces a 5 kHz PLL signal. This signal is then fed through a control circuit to the phase detector part of Q₃₀₈ (MC14568B), where the signal is compared with its reference signal. As a result, the difference of both signals produces a DC voltage which is delivered through a lowpass filter to the VCO circuit.

The programmed data from the diode matrix sets the dividing ratio of programmable counters Q_{303} and Q_{307} . Also, the 1 MHz step programming data from the diode matrix is delivered to D/A converters, which produce the preset voltage for the VCO and the control voltage for the auto-tune circuits.

Reference oscillator Q_{315} (2SC535B) generates a 7.5 MHz signal which is delivered to the divider section of Q_{308} , where the signal is divided by 1500, providing a 5 kHz reference signal for the phase comparator section.

When any phase difference is present between the divided VCO signal and its reference signal, the DC voltage from the phase comparator compensates to lock the PLL circuit. While the PLL circuit is locked, the DC voltage from the phase comparator remains constant.

If the PLL loop is unlocked, an unlock signal from phase comparator Q_{308} appears, and is fed to gate circuit Q_{304} (HD74LS02P) and also to the PTT line, so as to open the PTT line and disable the transmitter.

Spurious Suppression at Antenna Jack

Spurious radiation from the antenna terminal is suppressed by: (1) a lowpass filter consisting of $C_{421} - C_{427}$ and $L_{410} - L_{412}$ in a three section pi configuration, providing more than 60 dB of harmonic suppression, and (2) T_{206} , C_{225} , D_{205} , T_{207} , $C_{226} - C_{229}$, D_{206} , T_{208} , C_{233} , D_{207} , T_{209} , $C_{234} - C_{237}$, D_{208} , T_{204} , C_{216} , D_{203} , T_{205} , $C_{218} - C_{221}$ and D_{204} , which attenuate non-harmonic spurious signals more than 60 dB.

Spurious Radiation from the Case, Power Cable, etc.

The following capacitors ensure maximum attenuation of spurious signals from the case, power cable and other areas: C_{211} , C_{222} , C_{230} , C_{238} , C_{239} , C_{240} , C_{243} , C_{246} , C_{293} , C_{294} , C_{141} , C_{336} , C_{337} , C_{368} , C_{357} , C_{413} , C_{415} and C_{405} . Coils are sealed where they could cause spurious radiation.

Deviation Circuit

The Instantaneous Deviation Control circuit (IDC) consists of D_{261} , D_{262} , R_{268} , R_{269} and R_{270} , which control the deviation level and limit the maximum deviation.

Audio Filtering

An active audio filter, consisting of Q_{209} (D), $R_{271} - R_{274}$ and $C_{267} - C_{269}$, provides attenuation of audio frequencies above 3 kHz @ -18 dB/octave referenced to 1 kHz.

Frequency Stability/Adjustment/Channel Selection

The operation frequencies for both transmit and receive are determined by the diode matrix circuit. The programmed codes of each channel control the dividing ratio of the programmable counter in the PLL local signal oscillator.

The diode matrix circuit can program the programmable dividing ratio for any eight TX and eight RX frequencies desired as follows:

Frequency Coverage: 134 MHz - 174 MHz
 Frequency TX: Frequency PLL +
 Frequency MOD/OSC
 Frequency MOD/OSC: 21.4 MHz

The frequency stability of the transmitter is determined by the frequency stability of PLL reference oscillator Q_{315}/X_{301} and the modulation oscillator Q_{201}/X_{201} . These oscillators' components have been carefully selected for cancelling reactance variation due to temperature change, for the purpose of temperature compensation.

Final Device Information

2SC2630 transistor:
 Collector 13.6V, 4.7A
 Base 0V
 Emitter 0V

For Service Manuals Contact
 MAURITRON TECHNICAL SERVICES
 8 Cherry Tree Rd, Chinnor
 Oxon OX9 4QY
 Tel: 01844-351694 Fax: 01844-352554
 Email: enquiries@maurtron.co.uk

CRYSTAL DATA

Function	RX Second Local	*TX Carrier/Modulator	Reference
Symbol Number	X101	X201	X301
Part Number	H0102050	H0102442	H0102384
Type of Holder	HC-18/U	HC-18/T	HC-18/U
Frequency	20.945 MHz	* 21.400 MHz	7.500 MHz
Oscillation Frequency	20.945 MHz	* 21.400 MHz	7.500 MHz
Load Capacity	30pF ± 0.3pF	Series Resonance	30pF
Drive Level	1mW ± 0.2mW	1mW ± 0.2mW	5mW
Shunt Capacity	7pF	7pF	4.8pF ± 0.3pF
Frequency Tolerance	± 20ppm	± 10ppm	± 20ppm
Frequency Stability	± 20ppm	± 10ppm	± 30ppm
Equivalent Resistance	Less than 50 ohms	Less than 25 ohms	Less than 40 ohms
Operation Mode	Fundamental	Fundamental	Fundamental

* Actual Frequency: 21.4064 MHz with CI meter.
(Determined by circuit)

For Service Manuals Contact
MAURITRON TECHNICAL SERVICES
8 Cherry Tree Rd, Chinnor
Oxon OX9 4QY
Tel:- 01844-351694 Fax:- 01844-352554
Email:- enquiries@mauritron.co.uk

		BAND A	BAND B	BAND C	BAND D	BAND E
f_{RX}/f_{TX}		MHz 134.000 – 143.995 (*134.300 – 144.2875)	MHz 144.000 – 153.995 (*144.300 – 154.2875)	MHz 154.000 – 163.995 (*154.300 – 164.2875)	MHz 164.000 – 173.995 (*164.300 – 174.2875)	MHz 150.000 – 159.995 (*150.300 – 160.2875)
f_{PLL}		112.600 – 122.595 (*112.900 – 122.8875)	122.600 – 132.595 (*122.900 – 132.8875)	132.600 – 142.595 (*132.900 – 142.8875)	142.600 – 152.595 (*142.900 – 152.8875)	128.600 – 138.595 (*128.900 – 138.8875)
Divider Ratio	N1 Preset	1000	1200	1200	1400	1200
	N1 Matrix	100 – 199	0 – 99	100 – 199	0 – 99	80 – 179
	N2 Preset	520 (*460)	520 (*460)	520 (*460)	520 (*460)	120 (*140)
	N2 Matrix	0 – 19 (*4 – 18)	0 – 19 (*4 – 18)	0 – 19 (*4 – 18)	0 – 19 (*4 – 18)	0 – 19 (*4 – 18)
	N	$1100 \times 16 + 520 = 22520$ to $1199 \times 20 + 529 = 24519$ (*1100x16+464=18064) to (*1199x16+478=19662)	$1200 \times 20 + 520 = 24520$ to $1299 \times 20 + 539 = 26519$ (*1200x16+464=19664) to (*1299x16+478=21262)	$1300 \times 20 + 520 = 26520$ to $1399 \times 20 + 539 = 28519$ (*1300x16+464=21264) to (*1399x16+478=22862)	$1400 \times 20 + 520 = 28520$ to $1499 \times 20 + 539 = 30519$ (*1400x16+464=22864) to (*1399x16+478=22862)	$1280 \times 20 + 120 = 25720$ to $1379 \times 20 + 139 = 27719$ (*1280x16+144=20624) to (*1379x16+158=22222)

* for 12.5 kHz/step model $N = \frac{f_{PLL}(\text{MHz})}{0.005(\text{MHz})} = 20N1 + N2$

$f_{PLL} = f_{TX(RX)} - 21.4(\text{MHz})$

FTC-2640 FREQUENCY RELATIONSHIPS

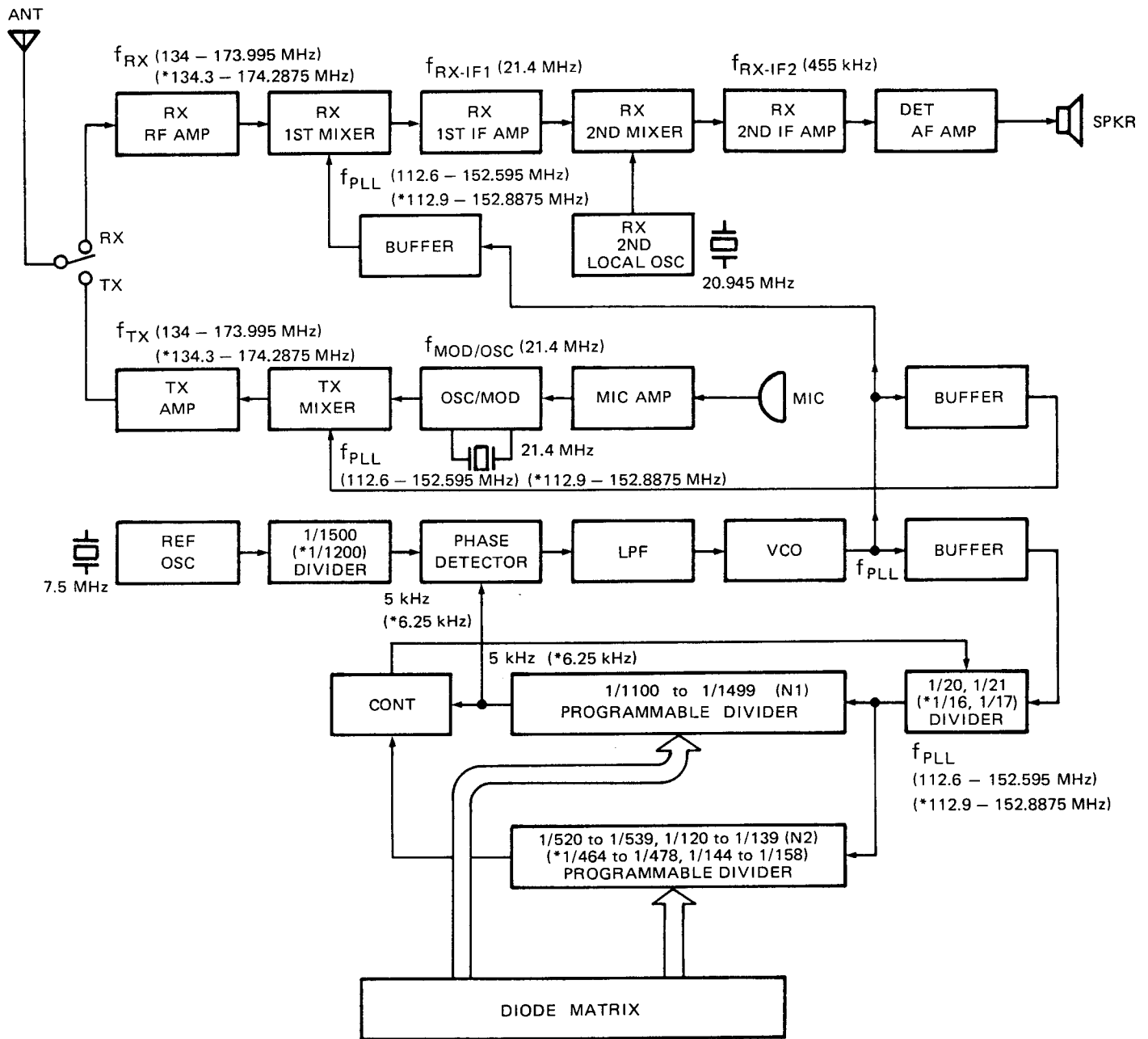

(* 12.5 kHz/step model)

For Service Manuals Contact
MAURITRON TECHNICAL SERVICES
 8 Cherry Tree Rd, Chinnor
 Oxon OX9 4QY
 Tel:- 01844-351694 Fax:- 01844-352554
 Email:- enquiries@mauritron.co.uk

BAND PROGRAMMING

1. Select the 10 MHz band to be used for operation, and note its corresponding letter:

- 134 – 144 MHz BAND A
- *134.3 – 144.3 MHz BAND A (12.5 kHz)
- 144 – 154 MHz BAND B
- *144.3 – 154.3 MHz BAND B (12.5 kHz)
- 154 – 164 MHz BAND C
- *154.3 – 164.3 MHz BAND C (12.5 kHz)
- 164 – 174 MHz BAND D
- *164.3 – 174.3 MHz BAND D (12.5 kHz)
- 150 – 160 MHz BAND E (RCC)
- *150.3 – 160.3 MHz BAND E (12.5 kHz)

2. Referring to Figure 2-2, install the jumpers as shown for the band selected. For example, if you are programming the FTC-2640 to operate within the range of 154 to 164 MHz (*154.3 to 164.3 MHz), you noted in step 1 that this is BAND C (*BAND C–12.5 kHz). So from Figure 2-2 you see that you must jumper TP₃₀₁ to TP₃₀₃, TP₃₀₆ to TP₃₀₈ and TP₃₀₄ to TP₃₀₅.

Note that in the case of the BAND E (RCC BAND), *BAND E–12.5 kHz, diodes D₃₀₆ and D₃₀₇ must be removed (or simply cut) in addition to the illustrated jumper installation.

SIMPLEX/DUPLEX PROGRAMMING

1. If you intend that all channels be simplex, simply install a jumper between pins 2 and 3 of J₅₀₁, as shown in Figure 2-1.
2. If some channels are to be semi-duplex, determine which of channels 1 through 8 are to be simplex channels. Referring to Figure 2-1, locate Matrix Column C on the circuit board and install jumpers in Column C between the Transmit Row and the Receive Row for each simplex channel. For example; if Channel 1 is to be simplex, connect a jumper from Row T₁ (nearest P₅₀₁) to Row R₁ (middle Row) in Column C (end column near J₅₀₁).

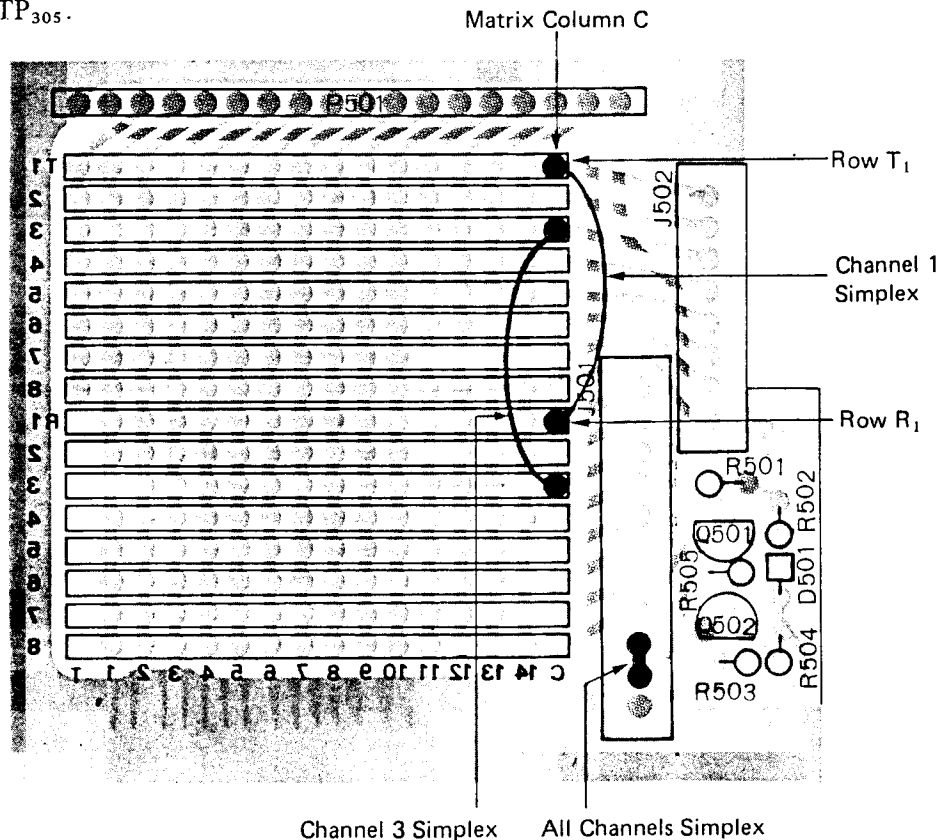
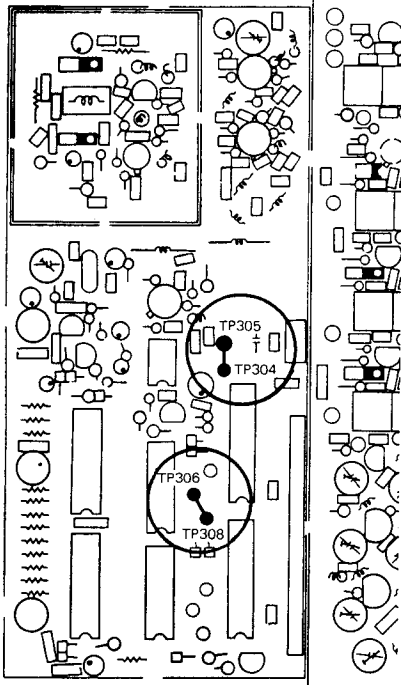

Figure 2-1
Viewed from solder side

For Service Manuals Contact
MAURITRON TECHNICAL SERVICES
 8 Cherry Tree Rd, Chinnor
 Oxon OX9 4QY
 Tel:- 01844-351694 Fax:- 01844-352554
 Email:- enquires@mauritron.co.uk

BAND SELECT JUMPER CONNECTIONS



BAND A, A(12.5 kHz)

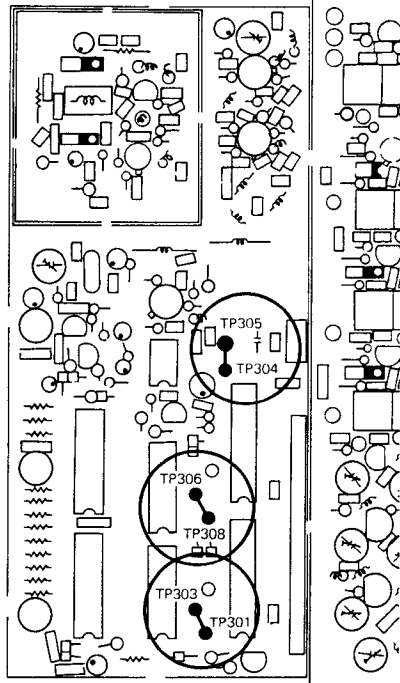

BAND B, B(12.5 kHz) and C(12.5 kHz)

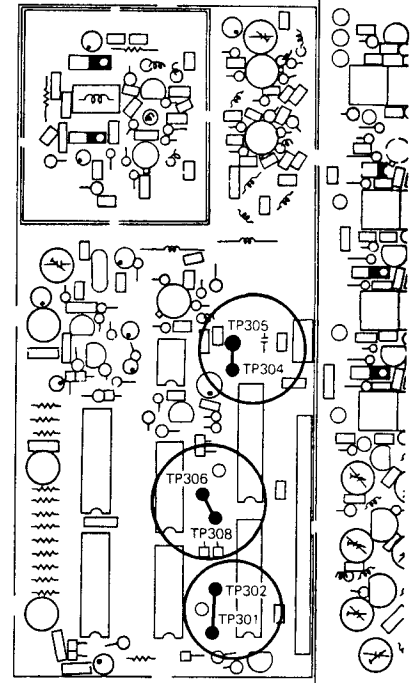

BAND D, D(12.5 kHz)

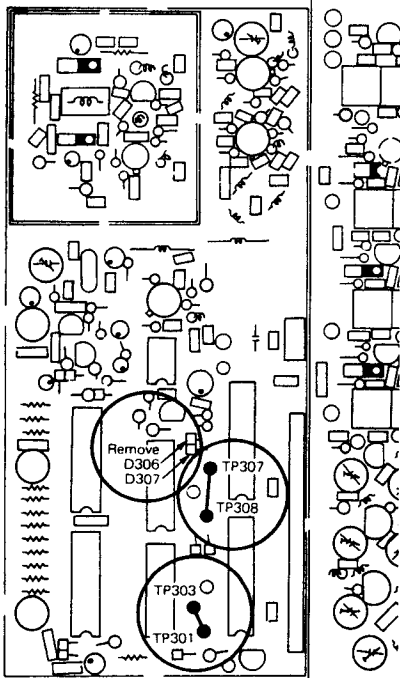

BAND E, E(12.5 kHz)

Under the Matrix Board

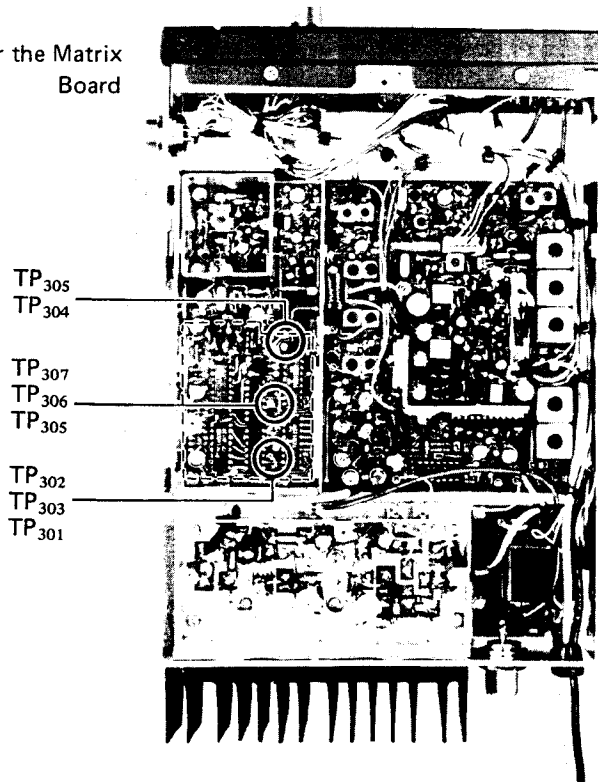

Figure 2-2

MAIN BOARD PLL SECTION (UNDER THE MATRIX BOARD)

**CHANNEL FREQUENCY PROGRAMMING*
FOR 5 kHz/STEP MODEL**

Note: Simplex channels are fully programmed by installing diodes in the Transmit Row of the Diode Matrix only. The Receive Row is not used for simplex channels. Those diodes in Column T (nearest the edge of the circuit board) enable the Transmit function. If you intend to install a channel for Receive only you must install the jumpers as described in the simplex channel programming step and install the diode Row in the Transmit section of the Matrix, cutting the diode in the Column T position to disable Transmit. Be careful not to cut this diode when programming the channel frequency, unless you intend to disable transmit on that channel.

1. Separate the desired channel frequency into 5 and 10 kHz, 100 kHz, and MHz segments as follows:

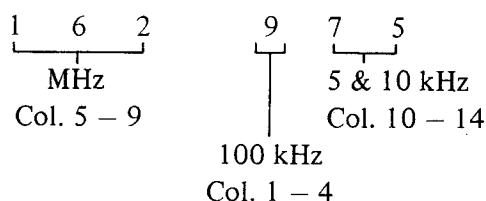

Matrix Columns 1** through 4 are used to program the 100 kHz digit.

Matrix Columns 5 through 9 program the MHz digits.

Matrix Columns 10 through 14 program the 5 and 10 kHz digits.

* For RCC (Radio Common Carrier) operation, install the jumpers and cut the diodes as shown in Figure 2-2 BAND E. Then program the channel frequencies according to Figure 2-6 on page 2-16.

** Notice that Column position 1 in the array is not the edge position, but second from the edge, since the T Column position is the first diode at the edge.

2. Referring to Table 2-1 and the Example Tables, program the 5 and 10 kHz digits of your channel frequency by removing the diodes in Column positions 10 through 14 corresponding with the 0s shown on the Line for your frequency.

For example, using the above frequency of 162.975 MHz, the 5 and 10 kHz digits are 75 (0.075 MHz). Now referring to Table 2-1, the 75 kHz line indicates that the diodes in Column positions 11 and 13 must be cut.

3. Program the 100 kHz digit in the same manner from the data in Table 2-3, cutting the appropriate diodes in Columns 1 through 4. Thus for the above frequency, the 100 kHz digit is 9, and from Table 2-3 we see that the diodes in Column positions 2 and 3 must be cut.

4. To program the MHz digits repeat the same procedure as with the other digits, this time referring to Table 2-2. Note that this Table is divided into sections A, B, C, D and E corresponding with the BAND selected by the jumpers installed during Band Programming. For our example of 162.975 MHz, the MHz digits are 162, and in the Table we see that this frequency is in Section C, corresponding with the BAND programmed via the jumpers in an earlier example. We also see from the Table that the diodes in Column

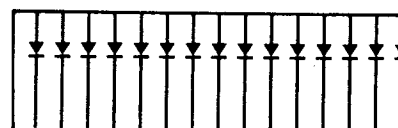
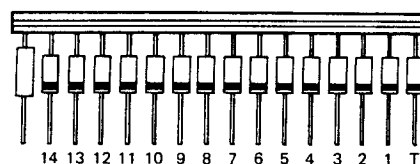
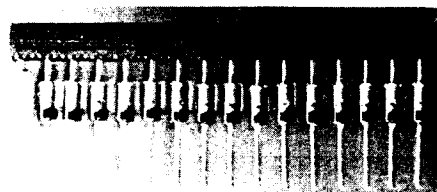

For Service Manuals Contact
MAURITRON TECHNICAL SERVICES
 8 Cherry Tree Rd, Chinnor
 Oxon OX9 4QY
 Tel:- 01844-351694 Fax:- 01844-352554
 Email:- enquiries@mauritron.co.uk

DIODE NO.	5 and 10 kHz digits				
	14	13	12	11	10
kHz	50	5x2 ³	5x2 ²	5x2 ¹	5x2 ⁰
00	0	0	0	0	0
05	0	0	0	0	1
10	0	0	0	1	0
15	0	0	0	1	1
20	0	0	1	0	0
25	0	0	1	0	1
30	0	0	1	1	0
35	0	0	1	1	1
40	0	1	0	0	0
45	0	1	0	0	1
50	1	0	0	0	0
55	1	0	0	0	1
60	1	0	0	1	0
65	1	0	0	1	1
70	1	0	1	0	0
75	1	0	1	0	1
80	1	0	1	1	0
85	1	0	1	1	1
90	1	1	0	0	0
95	1	1	0	0	1

Table 2-1

DIODE NO.	134 – 173 MHz (BAND A, B, C, D)					150 – 159 MHz (BAND E)				
	9	8	7	6	5	9	8	7	6	5
MHz	*	+2 ³	+2 ²	+2 ¹	+2 ⁰	*	+2 ³	+2 ²	+2 ¹	+2 ⁰
134	1	0	0	0	0					
135	1	0	0	0	1					
136	1	0	0	1	0					
137	1	0	0	1	1					
138	1	0	1	0	0					
139	1	0	1	0	1					
140	1	0	1	1	0					
141	1	0	1	1	1					
142	1	1	0	0	0					
143	1	1	0	0	1					
144	0	0	0	0	0					
145	0	0	0	0	1					
146	0	0	0	1	0					
147	0	0	1	1	1					
148	0	0	1	0	0					
149	0	0	1	0	1					
150	0	0	1	1	0	0	1	0	0	0
151	0	0	1	1	1	0	1	0	0	1
152	0	1	0	0	0	1	0	0	0	0
153	0	1	0	0	1	1	0	0	0	1
154	1	0	0	0	0	1	0	0	1	0
155	1	0	0	0	1	1	0	0	1	1
156	1	0	0	1	0	1	0	1	0	0
157	1	0	0	1	1	1	0	1	0	1
158	1	0	1	0	0	1	0	1	1	0
159	1	0	1	0	1	1	0	1	1	1
160	1	0	1	1	0					
161	1	0	1	1	1					
162	1	1	0	0	0					
163	1	1	0	0	1					
164	0	0	0	0	0					
165	0	0	0	0	1					
166	0	0	0	1	0					
167	0	0	0	1	1					
168	0	0	1	0	0					
169	0	0	1	0	1					
170	0	0	1	1	0					
171	0	0	1	1	1					
172	0	1	0	0	0					
173	0	1	0	0	1					

* BAND A 1 → 134
 BAND B 0 → 144
 BAND C 1 → 154
 BAND D 0 → 164
 BAND E 0 → 150
 BAND E 1 → 152

DIODE NO.	100 kHz digits			
	4	3	2	1
kHz	100 x2 ³	100 x2 ²	100 x2 ¹	100 x2 ⁰
000	0	0	0	0
100	0	0	0	1
200	0	0	1	0
300	0	0	1	1
400	0	1	0	0
500	0	1	0	1
600	0	1	1	0
700	0	1	1	1
800	1	0	0	0
900	1	0	0	1

Table 2-3

Table 2-2

For Service Manuals Contact
 MAURITRON TECHNICAL SERVICES
 8 Cherry Tree Rd, Chinnor
 Oxon OX9 4QY
 Tel: 01844-351694 Fax: 01844-352554
 Email: enquiries@mauritron.co.uk

DIODE NO.	5 and 10 kHz digits				
	14	13	12	11	10
kHz	50	5x2 ³	5x2 ²	5x2 ¹	5x2 ⁰
00	0	0	0	0	0
05	0	0	0	0	1
10	0	0	0	1	0
15	0	0	0	1	1
F2(T) → 20	0	0	1	0	0
25	0	0	1	0	1
30	0	0	1	1	0
35	0	0	1	1	1
40	0	1	0	0	0
45	0	1	0	0	1
F3(R) → 50	1	0	0	0	0
55	1	0	0	0	1
F2(R) → 60	1	0	0	1	0
65	1	0	0	1	1
70	1	0	1	0	0
F1 → 75	1	0	1	0	1
80	1	0	1	1	0
85	1	0	1	1	1
90	1	1	0	0	0
95	1	1	0	0	1

DIODE NO.	134 - 173 MHz (BAND A, B, C, D)					150 - 159 MHz (BAND E)				
	9	8	7	6	5	9	8	7	6	5
MHz	*	+2 ³	+2 ²	+2 ¹	+2 ⁰	*	+2 ³	+2 ²	+2 ¹	+2 ⁰
134	1	0	0	0	0					
135	1	0	0	0	1					
136	1	0	0	1	0					
137	1	0	0	1	1					
138	1	0	1	0	0					
139	1	0	1	0	1					
140	1	0	1	1	0					
141	1	0	1	1	1					
142	1	1	0	0	0					
143	1	1	0	0	1					
144	0	0	0	0	0					
145	0	0	0	0	1					
146	0	0	0	1	0					
147	0	0	0	1	1					
148	0	0	1	0	0					
149	0	0	1	0	1					
150	0	0	1	1	0	0	1	0	0	0
151	0	0	1	1	1	0	1	0	0	1
152	0	1	0	0	0	1	0	0	0	0
153	0	1	0	0	1	1	0	0	0	1
154	1	0	0	0	0	1	0	0	1	0
F2(R) → 155	1	0	0	0	1	1	0	0	1	1
156	1	0	0	1	0	1	0	1	0	0
157	1	0	0	1	1	1	0	1	0	1
F2(T) → 158	1	0	1	0	0	1	0	1	1	0
159	1	0	1	0	1	1	0	1	1	1
160	1	0	1	1	0					
161	1	0	1	1	1					
F1 → 162	1	1	0	0	0					
F3(R) → 163	1	1	0	0	1					
164	0	0	0	0	0					
165	0	0	0	0	1					
166	0	0	0	1	0					
167	0	0	0	1	1					
168	0	0	1	0	0					
169	0	0	1	0	1					
170	0	0	1	1	0					
171	0	0	1	1	1					
172	0	1	0	0	0					
173	0	1	0	0	1					

* BAND A 1 → 134
 BAND B 0 → 144
 BAND C 1 → 154
 BAND D 0 → 164
 BANDE 0 → 150
 BANDE 1 → 152

DIODE NO.	100 kHz digits			
	4	3	2	1
kHz	100 x2 ³	100 x2 ²	100 x2 ¹	100 x2 ⁰
000	0	0	0	0
100	0	0	0	1
200	0	0	1	0
300	0	0	1	1
400	0	1	0	0
500	0	1	0	1
600	0	1	1	0
700	0	1	1	1
800	1	0	0	0
F1, F3(R) ← 900	1	0	0	1

For Service Manuals Contact
MAURITRON TECHNICAL SERVICES
 8 Cherry Tree Rd, Chinnor
 Oxon OX9 4QY
 Tel:- 01844-351694 Fax:- 01844-352554
 Email:- enquiries@mauritron.co.uk

EXAMPLE TABLES

EXAMPLE 2. Channel 3; 163.950 MHz Receive Only (Figures 2-5 and 2-9, and Example Tables).

Note again that this frequency is located within the 154 – 164 MHz C BAND, since all channels programmed into the FTC-2640 must be within the same band. Recalling the NOTE at the beginning of the Channel Frequency Programming section, we will first begin the Receive Only programming by wiring Channel 3 as for Simplex operation.

1. Referring to Figure 2-1, install a jumper between Matrix Row T3 and Row R3 in Matrix Column C.
2. Now for frequency programming, separate the frequency into the three segments: 163 MHz, 900 kHz and 50 kHz.
3. Referring to the respective programming Tables for these frequency segments, cut diodes in Column positions 2, 3, 6, 7, 10, 11, 12 and 13.
4. Again recalling the NOTE at the beginning of the Channel Frequency Programming section, we must also cut the diode in the Column T position to disable Transmit (if we leave this diode in place the channel will be an ordinary simplex channel).
5. Install this diode assembly into the circuit at Row T3, and solder the remaining diodes of the assembly into place.

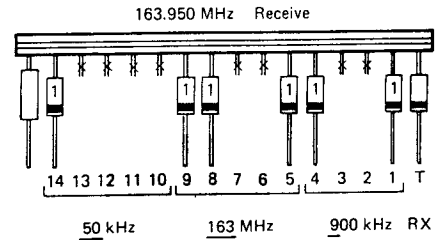

Figure 2-9 (X cut)

For Service Manuals Contact
MAURITRON TECHNICAL SERVICES
 8 Cherry Tree Rd, Chinnor
 Oxon OX9 4QY
 Tel:- 01844-351694 Fax:- 01844-352554
 Email:- enquiries@mauritron.co.uk

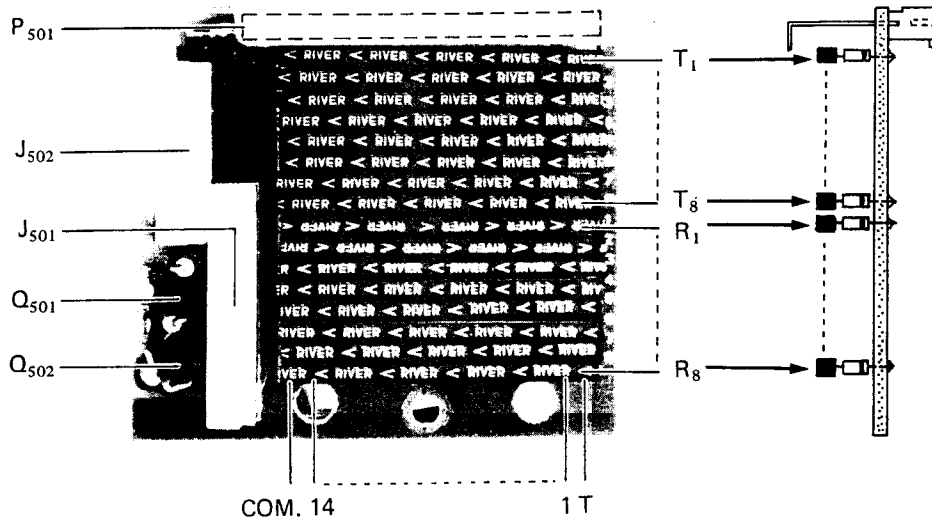
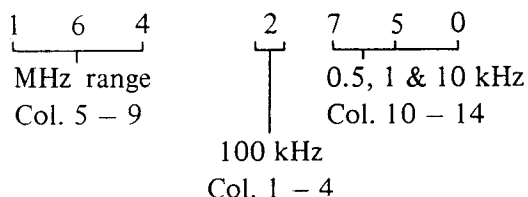

Figure 2-10

CHANNEL FREQUENCY PROGRAMMING FOR 12.5 kHz/STEP MODEL

Note: Simplex channels are fully programmed by installing diodes in the Transmit Row of the Diode Matrix only. The Receive Row is not used for simplex channels. Those diodes in Column T (nearest the edge of the circuit board) enable the Transmit function. If you intend to install a channel for Receive only you must install the jumpers as described in the simplex channel programming step and install the diode Row in the Transmit section of the Matrix, cutting the diode in the Column T position to disable Transmit. Be careful not to cut this diode when programming the channel frequency, unless you intend to disable transmit on that channel.

1. Separate the desired channel frequency into 0.5, 1 & 10 kHz; 100 kHz; and MHz range segments as follows:



Matrix Columns 1** through 4 are used to program the 100 kHz digit.

Matrix Columns 5 through 9 program the MHz range, each of which has a lower limit of $X + .3000$ MHz and an upper limit of $(X + 1) + .2875$ MHz. (X is any whole number of MHz within the operating band).

Matrix Columns 10 through 14 program the 0.5, 1 & 10 kHz digits. (The 0.5 kHz digit can be only zero or 0.5.)

** Notice that Column position 1 in the array is not the edge position, but second from the edge, since the T Column position is the first diode at the edge.

2. Referring to Table 2-4 and the Example Tables, program the 0.5, 1 & 10 kHz digits of your channel frequency by removing the diodes in Column positions 10 through 14 corresponding with the 0s shown on the Line for your frequency.

For example, using the above frequency of 164.2750 MHz, the 0.5, 1 & 10 kHz digits are 75.0. Now referring to Table 2-4, the 75.0 kHz line indicates that the diodes in Column positions 10 and 13 must be cut.

3. Program the 100 kHz digit in the same manner from the data in Table 2-6, cutting the appropriate diodes in Columns 1 through 4. Thus for the above frequency, the 100 kHz digit is 2 (200 kHz), and from Table 2-6 we see that the diodes in Column positions 2 and 3 must be cut.

4. To program the MHz range repeat the same procedure as with the other digits, this time referring to Table 2-5. Note that this Table is divided into sections A, B, C, D and E corresponding with the BAND selected by the jumpers installed during Band Programming. For our example of 164.275 MHz, the MHz range is 163.3 – 164.2, and in the Table we see that this frequency is in Section C, corresponding with the BAND programmed via the jumpers in an earlier example. Notice that, although the desired frequency is above 164.2 MHz, the 163.3 – 164.2 MHz range is used for programming. This is because it is the 100 kHz digit that sets the limit of the MHz range (in this case 200 kHz), and the

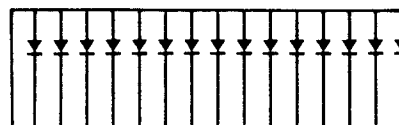
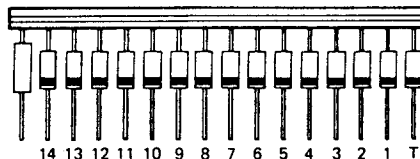
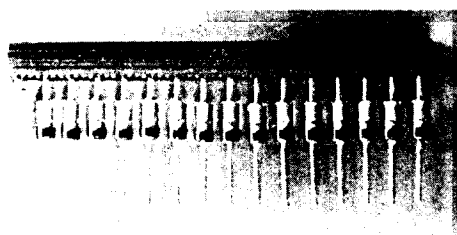

For Service Manuals Contact
MAURITRON TECHNICAL SERVICES
 8 Cherry Tree Rd, Chinner
 Oxon OX9 4QY
 Tel: 01844-351694 Fax: 01844-352554
 Email: enquiries@mauritron.co.uk

next higher range can not be used for any frequencies below 164.3 MHz. We see from the Table that the diodes in Column positions 6 and 7 must be cut. The diode assembly should now match the program shown in Channel F1 on Figures 2-10 and 2-11.

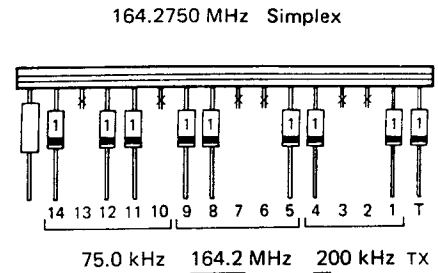

Figure 2-10 (X ... cut)

FTC-2640 PROGRAM BAND C (12.5 kHz)

CHANNEL		FREQUENCY (MHz)	COLUMN POSITION (DIODE) NO.														
DISPLAY	MATRIX BOARD (ROW)		14	13	12	11	10	9	8	7	6	5	4	3	2	1	T
F 1	T 1	164.2750	1	0	1	1	0	1	1	0	0	1	1	0	0	1	1
	R 1																
F 2	T 2	159.8000	0	0	1	0	0	1	0	1	0	1	0	1	0	1	1
	R 2	156.3500	1	0	0	1	0	1	0	0	1	0	0	0	0	0	0
F 3	T 3																
	R 3	163.2250	0	1	0	0	0	1	1	0	0	0	1	0	0	1	0
F 4	T 4																
	R 4																
F 5	T 5																
	R 5																
F 6	T 6																
	R 6																
F 7	T 7																
	R 7																
F 8	T 8																
	R 8																

Figure 2-11

For Service Manuals Contact
MAURITRON TECHNICAL SERVICES
 8 Cherry Tree Rd, Chinnor
 Oxon OX9 4QY
 Tel:- 01844-351694 Fax:- 01844-352554
 Email:- enquiries@mauritron.co.uk

ADDITIONAL FREQUENCY PROGRAMMING EXAMPLES

EXAMPLE 1. Channel 2 Duplex; 159.8000 Transmit, 156.3500 Receive (Figures 2-11, 2-12 and 2-13; and Example Tables).

For this example we will again assume that the FTC-2640 is already programmed with the jumpers described in the Band Programming section to operate in the 154.3 – 164.28 MHz band (BAND C) (12.5 kHz). Since Channel 2 is to be duplex, we do not install a jumper as described in the Simplex/Duplex Programming section.

- To program the transmit frequency, we will first separate the frequency into the components we will need:

159.8 is the MHz range,
 8 is the 100 kHz segment, and
 00.0 is the 0.5, 1 & 10 kHz segment.

- Now to program the 0.5, 1 & 10 kHz segment first; referring to Table 2-4, we find on the 00.0 kHz line that we must cut the diodes in Column positions 10, 11, 13, and 14.

- To program the 100 kHz segment; referring to Table 2-6, we find on the 800 kHz line that we must cut the diodes in Column positions 2 and 4.

- Similarly, for the MHz range segment; referring now to Table 2-5, we find on the 159.3 – 160.2 MHz line (Part E of the Table) that we must cut the diodes in Column positions 6 and 8.

- Now install the diode assembly into the circuit at Row T2 (marked on the circuit board), and solder the remaining diodes of the assembly into place.

- To program the receive frequency we again separate it into three segments:

156.3 is the MHz range segment,
 3 is the 100 kHz segment, and
 50.0 is the 0.5, 1 & 10 kHz segment.

- For the 0.5, 1 & 10 kHz segment we again refer to Table 2-4, and on the 50.0 kHz line we see that we must cut the diodes in positions 10, 12, and 13.
- For the 100 kHz segment we see in Table 2-6 that we cut all of the diodes in positions 1 through 4 (remember that position 1 is not the first diode in the row, but the second, since the T position is the first diode at the end of the row).
- For the MHz range segment we see in Table 2-5 (Part C) on the 156.3 – 157.2 MHz line that we must cut the diodes in positions 5, 7 and 8.
- Finally, install this diode assembly into the circuit at Row R2, and solder the remaining diodes of the assembly into place.

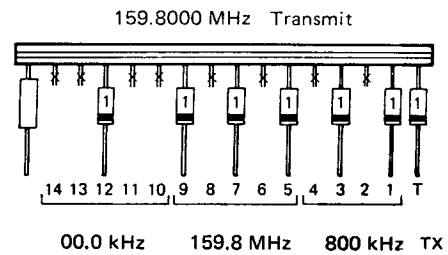

Figure 2-12 (X ... cut)

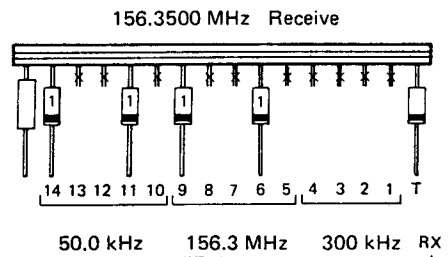

Figure 2-13 (X ... cut)

For Service Manuals Contact
MAURITRON TECHNICAL SERVICES
 8 Cherry Tree Rd, Chinnor
 Oxon OX9 4QY
 Tel:- 01844-351694 Fax:- 01844-352554
 Email:- enquiries@mauritron.co.uk

EXAMPLE 2. Channel 3; 163.2250 MHz Receive Only (Figures 2-11 Example Tables).

Note again that this frequency is located within the 154.3 – 164.3 MHz C(12.5 kHz) BAND, since all channels programmed into the FTC-2640 must be within the same band. Recalling the NOTE at the beginning of the Channel Frequency Programming section, we will first begin the Receive Only programming by wiring Channel 3 as for Simplex operation.

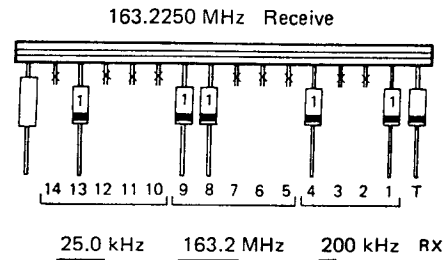

Figure 2-14 (X ... cut)

1. Referring to Figure 2-1, install a jumper between Matrix Row T3 and Row R3 in Matrix Column C.
2. Now for frequency programming, separate the frequency into the three segments: 163.2 MHz, 200 kHz and 25.0 kHz.
3. Referring to the respective programming Tables for these frequency segments, cut diodes in Column positions 2, 3, 5, 6, 7, 10, 11, 12 and 14.
4. Again recalling the NOTE at the beginning of the Channel Frequency Programming section, we must also cut the diode in the Column T position to disable Transmit (if we leave this diode in place the channel will be an ordinary simplex channel).
5. Install this diode assembly into the circuit at Row T3, and solder the remaining diodes of the assembly into place.

For Service Manuals Contact
MAURITRON TECHNICAL SERVICES
 8 Cherry Tree Rd, Chinnor
 Oxon OX9 4QY
 Tel:- 01844-351694 Fax:- 01844-352554
 Email:- enquires@mauritron.co.uk

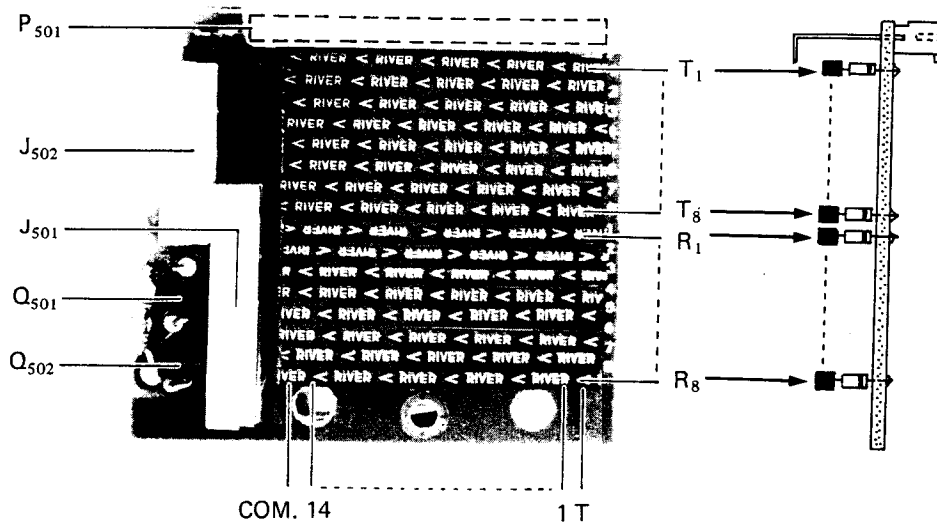

Figure 2-15

Use these blank diagrams for programming practice.

FTC-2640 PROGRAM BAND ()

CHANNEL		FREQUENCY (MHz)	COLUMN POSITION (DIODE) NO.													
DISPLAY	MATRIX BOARD (ROW)		14	13	12	11	10	9	8	7	6	5	4	3	2	1
F 1	T 1															
	R 1															
F 2	T 2															
	R 2															
F 3	T 3															
	R 3															
F 4	T 4															
	R 4															
F 5	T 5															
	R 5															
F 6	T 6															
	R 6															
F 7	T 7															
	R 7															
F 8	T 8															
	R 8															

For Service Manuals Contact
MAURITRON TECHNICAL SERVICES
 8 Cherry Tree Rd, Chinnor
 Oxon OX9 4QY
 Tel: 01844-351694 Fax: 01844-352554
 Email: enquiries@mauritron.co.uk

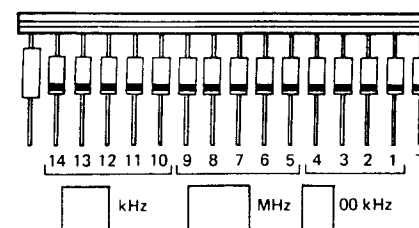
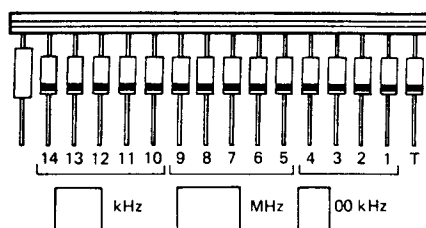
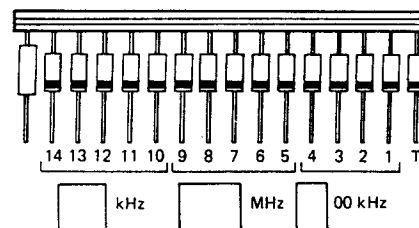
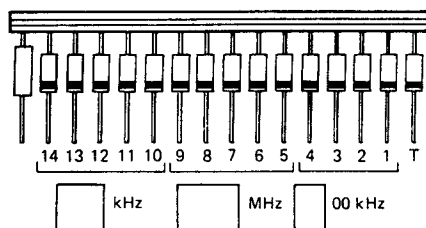
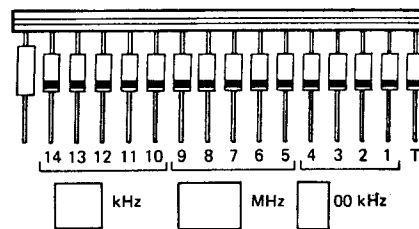
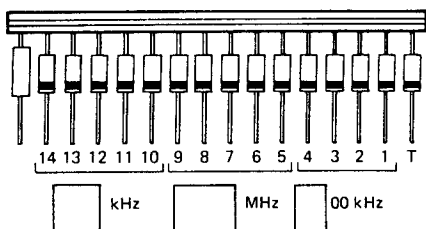
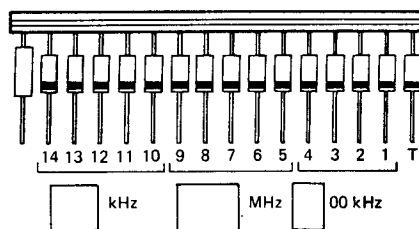
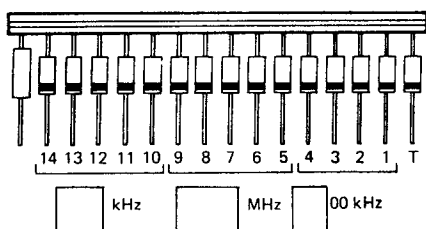

TECHNICAL NOTES

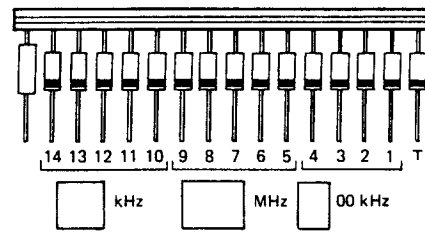
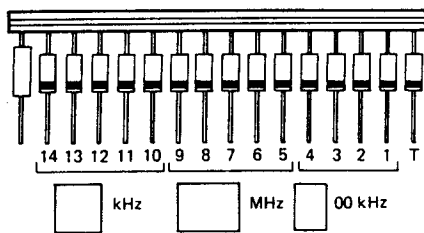
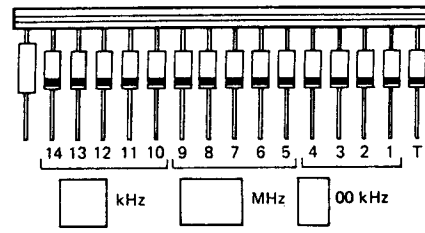
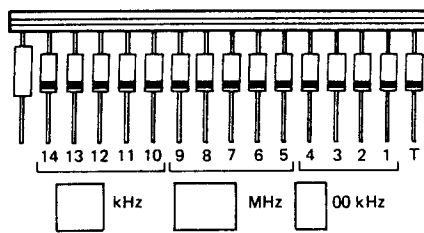
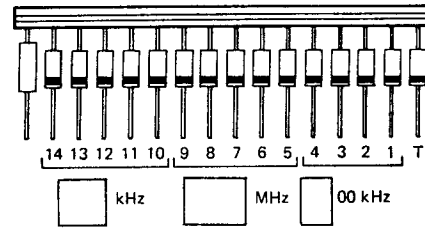
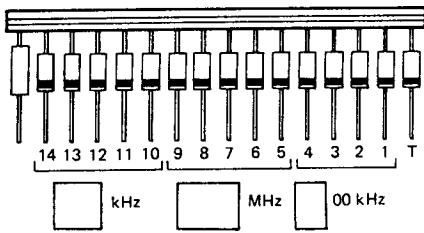
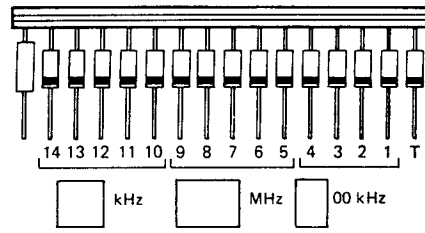
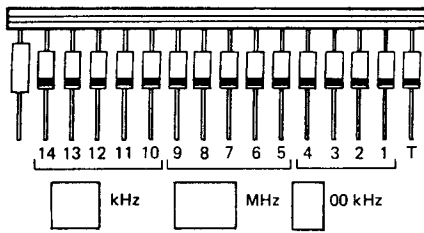
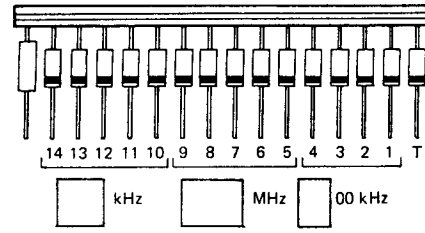
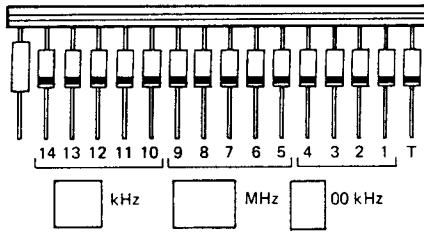
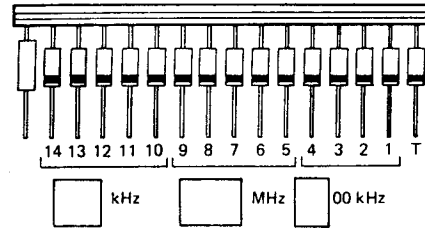
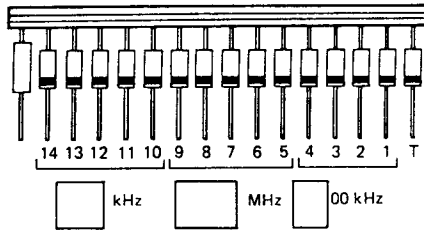

BAND TABLE (TUNING CAPACITORS)

	134 – 154 MHz (A, B) (134.3 – 154.3 MHz)		150 – 164 MHz (C, E) (150.3 – 164.3 MHz)		164 – 174 MHz (D) (164.3 – 174.3 MHz)	
	Part No.	Description	Part No.	Description	Part No.	Description
C102	K02182020	Ceramic CH 2pF (RD870-1CG 020C 63V)	-	Not used	-	Not used
C103	K06183100	" UJ 10pF (RD870-1UJ 100D 63V)	K06183070	Ceramic UJ 7pF (RD870-1UJ 070D 63V)	K06183070	Ceramic UJ 7pF (RD870-1UJ 070D 63V)
C106	K06183100	" UJ 10pF (RD870-1UJ 100D 63V)	K06183070	" UJ 7pF (RD870-1UJ 070D 63V)	K06183070	" UJ 7pF (RD870-1UJ 070D 63V)
C107	K06183090	" UJ 9pF (RD870-1UJ 090D 63V)	K06182040	" UJ 4pF (RD870-1UJ 040C 63V)	K06182040	" UJ 4pF (RD870-1UJ 040C 63V)
C111	K02182030	" CH 3pF (RD870-1CG 030C 63V)	K02182010	" CH 1pF (RD870-1CG 010C 63V)	K02182010	" CH 1pF (RD870-1CG 010C 63V)
C113	K06183100	" UJ 10pF (RD870-1UJ 100D 63V)	K06183070	" UJ 7pF (RD870-1UJ 070D 63V)	K06183070	" UJ 7pF (RD870-1UJ 070D 63V)
C115	K02182040	" CH 4pF (RD870-1CG 040C 63V)	K02182020	" CH 2pF (RD870-1CG 020C 63V)	K02182020	" CH 2pF (RD870-1CG 020C 63V)
C116	K06183100	" UJ 10pF (RD870-1UJ 100D 63V)	K06183070	" UJ 7pF (RD870-1UJ 070D 63V)	K06183070	" UJ 7pF (RD870-1UJ 070D 63V)
C118	K06185120	" UJ 12pF (RD870-1UJ 120J 63V)	K06183100	" UJ 10pF (RD870-1UJ 100D 63V)	K06183100	" UJ 10pF (RD870-1UJ 100D 63V)
C119	K06183100	" UJ 10pF (RD870-1UJ 100D 63V)	K06183070	" UJ 7pF (RD870-1UJ 070D 63V)	K06183070	" UJ 7pF (RD870-1UJ 070D 63V)
C120	K06182040	" UJ 4pF (RD870-1UJ 040C 63V)	K02182020	" CH 2pF (RD870-1CG 020C 63V)	K02182020	" CH 2pF (RD870-1CG 020C 63V)
C0201	K05183100	" RH 10pF (RD870-1RG 100D 63V)	K05183050	" RH 5pF (RD870-1RG 050C 63V)	K05183050	" RH 5pF (RD870-1RG 050C 63V)
C0202	K02182010	" CH 1pF (RD870-1CG 010C 63V)	K02182059	" CH 0.5pF (RD870-1CG 0R5C 63V)	K02182059	" CH 0.5pF (RD870-1CG 0R5C 63V)
C0203	K05182050	" RH 5pF (RD870-1RG 050C 63V)	K02182020	" CH 2pF (RD870-1CG 020C 63V)	K05182020	" CH 2pF (RD870-1CG 020C 63V)
C216	K06185150	" UJ 15pF (RD870-1UJ 150J 63V)	K06183100	" UJ 10pF (RD870-1UJ 100D 63V)	K06183100	" UJ 10pF (RD870-1UJ 100D 63V)
C217	K02182020	" CH 2pF (RD870-1CG020C 63V)	-	Not used	-	Not used
C219	K06185150	" UJ 15pF (RD870-1UJ 150J 63V)	K06183100	" UJ 10pF (RD870-1UJ 100D 63V)	K06183100	" UJ 10pF (RD870-1UJ 100D 63V)
C223	K02182040	" CH 4pF (RD870-1CG 040C 63V)	K02182020	" CH 2pF (RD870-1CG 020C 63V)	K02182020	" CH 2pF (RD870-1CG 020C 63V)
C225	K06185150	" UJ 15pF (RD870-1UJ 150J 63V)	K06183100	" UJ 10pF (RD870-1UJ 100D 63V)	K06183100	" UJ 10pF (RD870-1UJ 100D 63V)
C227	K06185150	" UJ 15pF (RD870-1UJ 150J 63V)	K06183100	" UJ 10pF (RD870-1UJ 100D 63V)	K06183100	" UJ 10pF (RD870-1UJ 100D 63V)
C231	K02182040	" CH 4pF (RD870-1CG 040C 63V)	K02182020	" CH 2pF (RD870-1CG 020C 63V)	K02182020	" CH 2pF (RD870-1CG 020C 63V)
C233	K06185150	" UJ 15pF (RD870-1UJ 150J 63V)	K06183100	" UJ 10pF (RD870-1UJ 100D 63V)	K06183100	" UJ 10pF (RD870-1UJ 100D 63V)
C235	K06185150	" UJ 15pF (RD870-1UJ 150J 63V)	K06183100	" UJ 10pF (RD870-1UJ 100D 63V)	K06183100	" UJ 10pF (RD870-1UJ 100D 63V)
C311	K06185470	" UJ 47pF (RD870-1UJ 470J 63V)	K06185150	" UJ 15pF (RD870-1UJ 150J 63V)	K06185150	" UJ 15pF (RD870-1UJ 150J 63V)
C312	K06185330	" UJ 33pF (RD870-1UJ 330J 63V)	K06185180	" UJ 18pF (RD870-1UJ 180J 63V)	K06185180	" UJ 18pF (RD870-1UJ 180J 63V)
C315	K06185220	" UJ 22pF (RD870-1UJ 220J 63V)	K06185120	" UJ 12pF (RD870-1UJ 120J 63V)	K06185120	" UJ 12pF (RD870-1UJ 120J 63V)
C363	K02183100	" CH 10pF (RD870-1CG 100D 63V)	K02182050	" CH 5pF (RD870-1CG 050C 63V)	K02182050	" CH 5pF (RD870-1CG 050C 63V)
C366	K02185390	" CH 39pF (RD871-1CG 390J 63V)	K02185390	" CH 39pF (RD871-1CG 390J 63V)	K02185560	" CH 56pF (RD872-2CG 560J 63V)
C409	K02185560	" CH 56pF (RD872-2CG 560J 63V)	K02185560	" CH 56pF (RD872-2CG 560J 63V)	K02185330	" CH 33pF (RD871-1CG 330J 63V)
C410	K02185680	" CH 68pF (RD873-2CG 680J 63V)	-	Not used	-	Not used
C421	K02185560	" CH 56pF (RD872-2CG 560J 63V)	K02185560	" CH 56pF (RD872-2CG 560J 63V)	-	Not used
C427	K02185150	" CH 15pF (RD870-1CG 150J 63V)	K02183090	" CH 9pF (RD870-1CG 090D 63V)	K02183070	" CH 7pF (RD870-1CG 070D 63V)
C434	K02185220	" CH 22pF (RD871-1CG 220J 63V)	-	Not used	-	Not used
C443	K02185220	" CH 22pF (RD871-1CG 220J 63V)	K02185180	" CH 18pF (RD870-1CG 180J 63V)	K02185180	" CH 18pF (RD870-1CG 180J 63V)
C445	K02185220	" CH 22pF (RD871-1CG 220J 63V)	K02185180	" CH 18pF (RD870-1CG 180J 63V)	K02185180	" CH 18pF (RD870-1CG 180J 63V)

MEMO

For Service Manuals Contact
MAURITRON TECHNICAL SERVICES
8 Cherry Tree Rd, Chinnor
Oxon OX9 4QY
Tel:- 01844-351694 Fax:- 01844-352554
Email:- enquiries@mauritron.co.uk

For Service Manuals Contact
MAURITRON TECHNICAL SERVICES
 8 Cherry Tree Rd, Chinnor
 Oxon OX9 4QY
 Tel: 01844-351694 Fax: 01844-352554
 Email: enquiries@maurifron.co.uk

BOARD LAYOUT

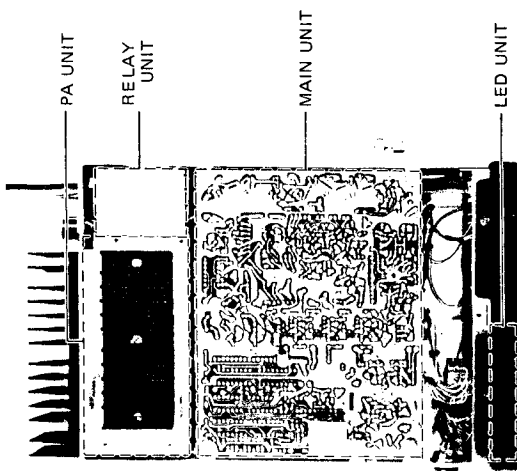

TOP VIEW

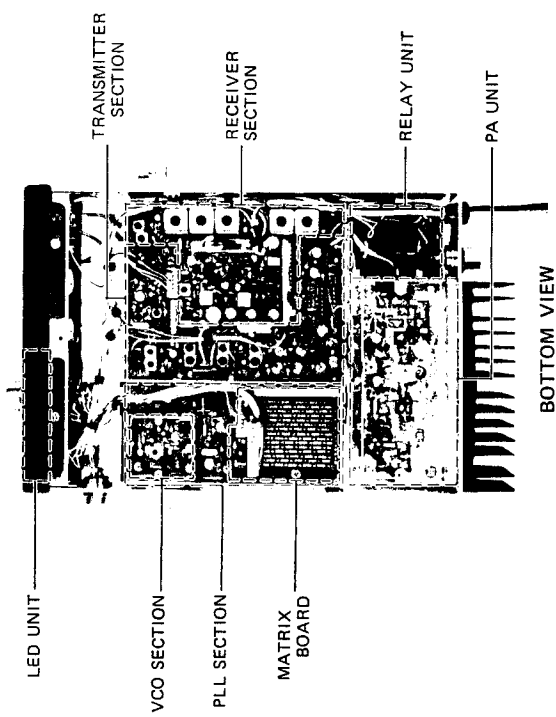

BOTTOM VIEW

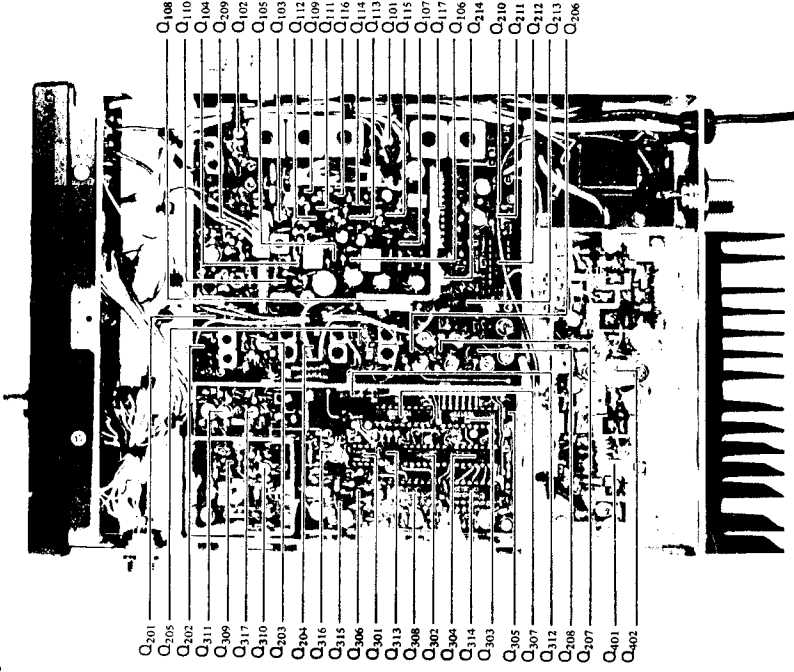

SEMICONDUCTOR LOCATIONS

For Service Manuals Contact
MAURITRON TECHNICAL SERVICES
8 Cherry Tree Rd. Chinnor
Oxon OX9 4QY
Tel: 01844-351694 Fax: 01844-352554
Email: enquiries@mauritron.co.uk

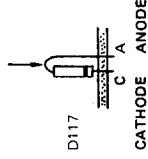

MAIN BOARD PARTS LAYOUT

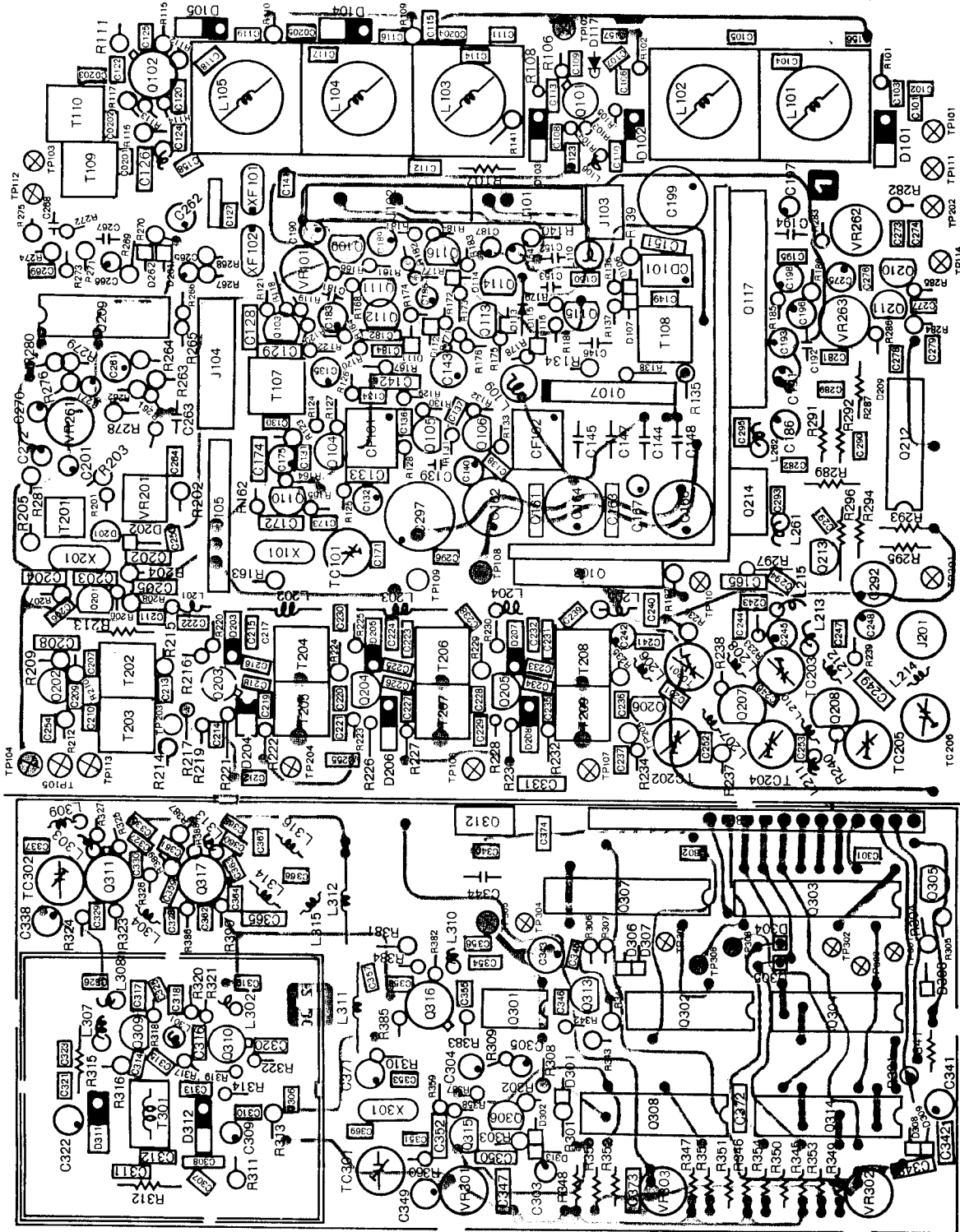

Viewed from component side

MAIN BOARD PARTS LAYOUT

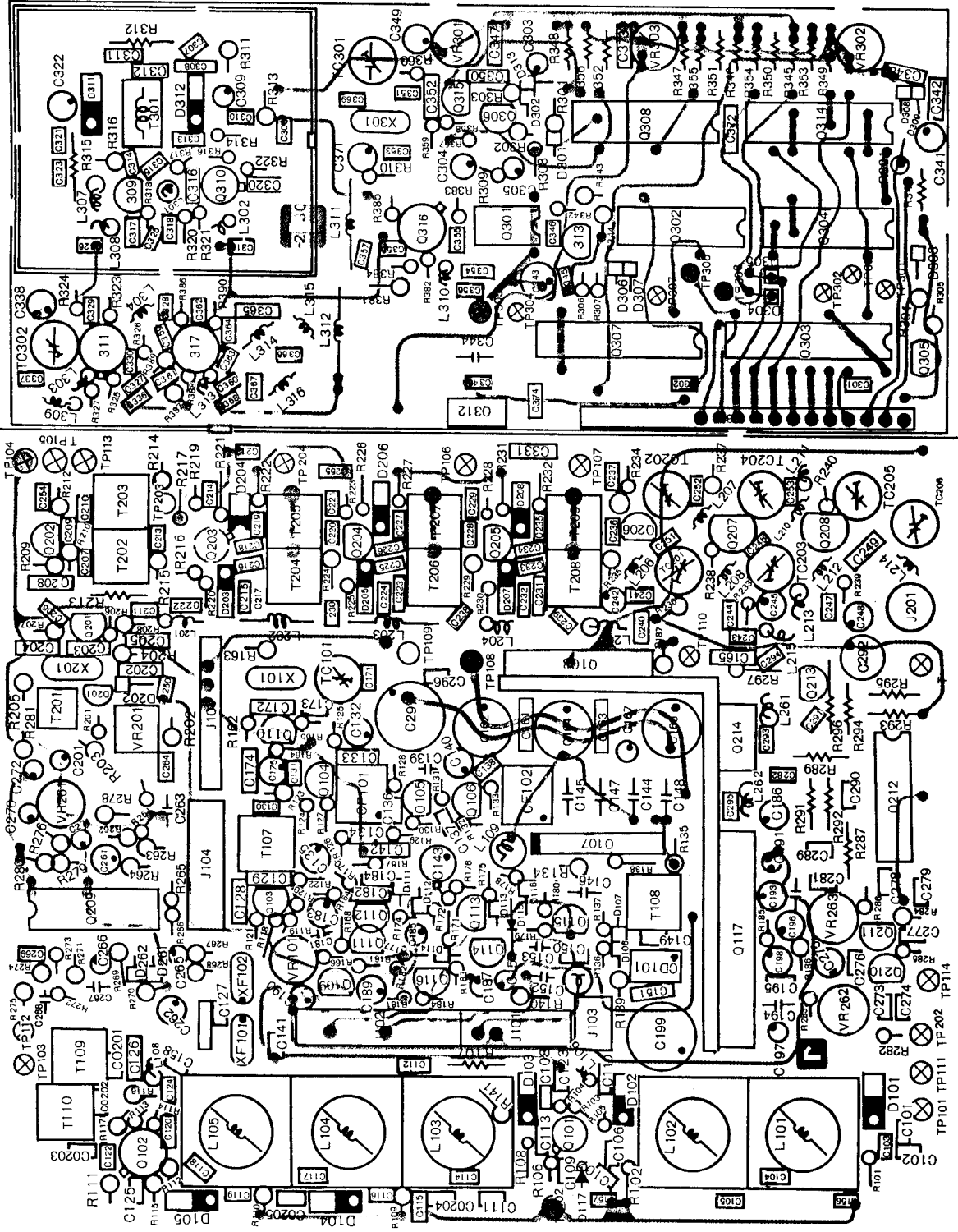

For Service Manuals Contact
MAURITRON TECHNICAL SERVICES
8 Cherry Tree Rd, Chinnor
Oxon OX9 4QY
Tel: 01844-351694 Fax: 01844-352554
Email: enquiries@mauritron.co.uk

Viewed from solder side

POWER AMPLIFIER BOARD PARTS LAYOUT

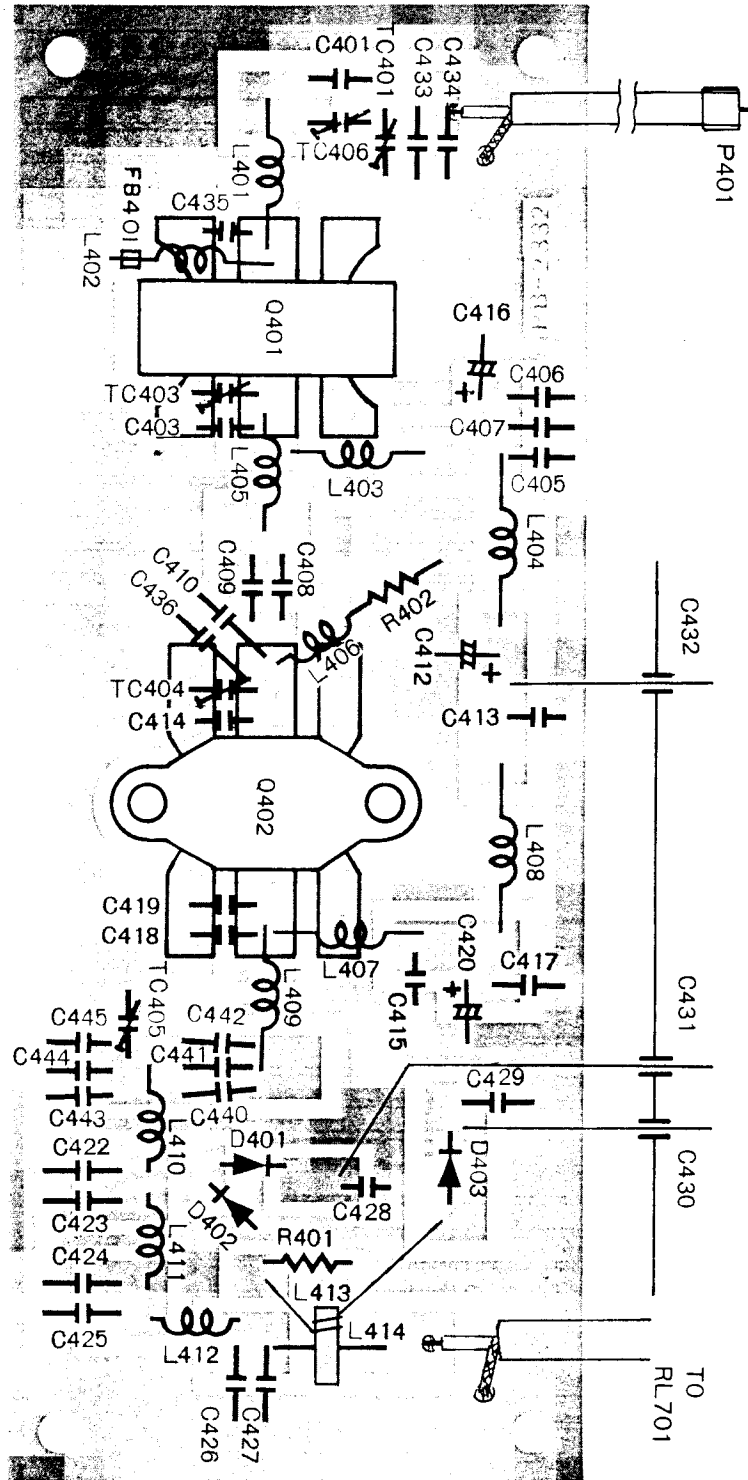

For Service Manuals Contact
MAURITRON TECHNICAL SERVICES
 8 Cherry Tree Rd, Chinnor
 Oxon OX9 4QY
 Tel: 01844-351694 Fax: 01844-352554
 Email: enquiries@mauritron.co.uk

DIODE MATRIX BOARD PARTS LAYOUT

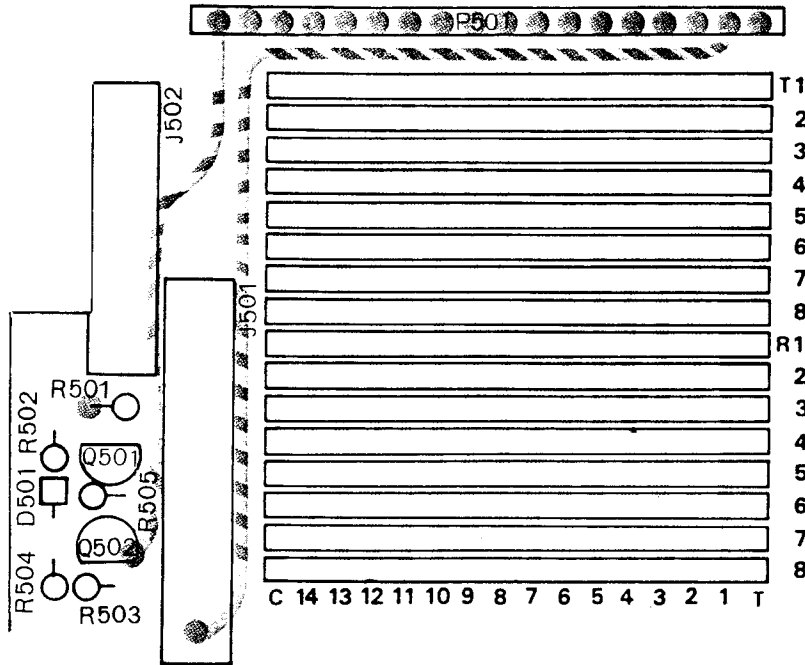

For Service Manuals Contact
MAURITRON TECHNICAL SERVICES
 8 Cherry Tree Rd, Chinnor
 Oxon OX9 4QY
 Tel: 01844-351694 Fax: 01844-352554
 Email: enquires@mauritron.co.uk

Viewed from component side

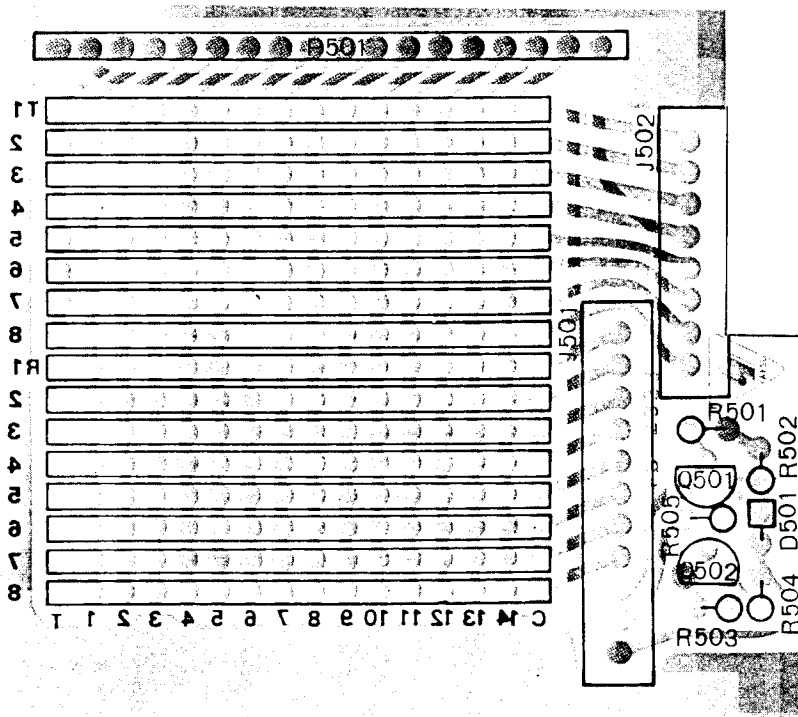

Viewed from solder side

LED BOARD PARTS LAYOUT

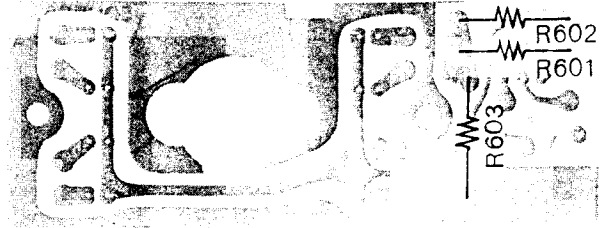
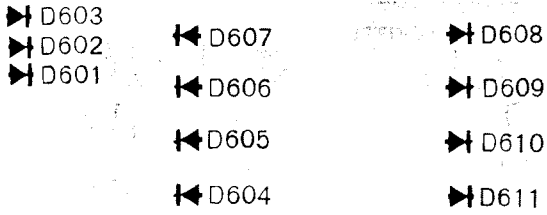

Viewed from LED side

Viewed from resistor side

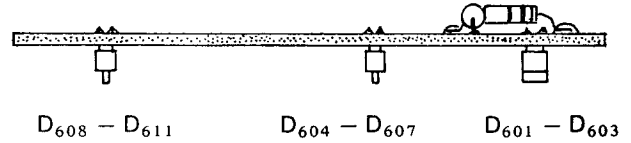
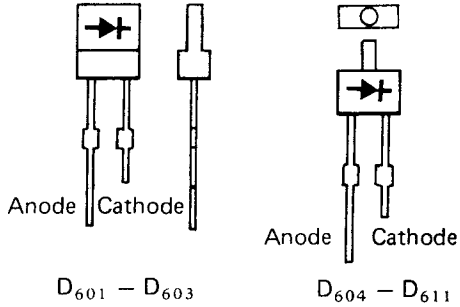

For Service Manuals Contact
MAURITRON TECHNICAL SERVICES
 8 Cherry Tree Rd, Chinnor
 Oxon OX9 4QY
 Tel:- 01844-351694 Fax:- 01844-352554
 Email:- enquiries@mauritron.co.uk

RELAY BOARD PARTS LAYOUT

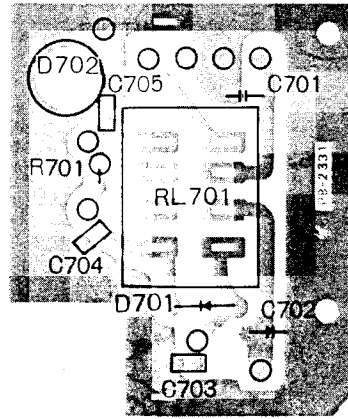
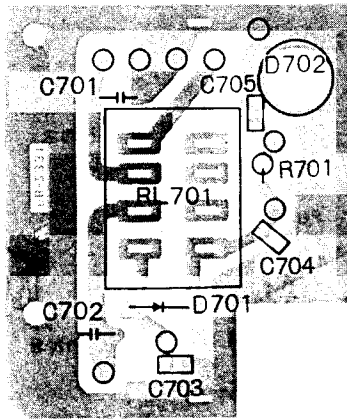

Viewed from component side

Viewed from solder side

Should the need for replacement of relays become necessary, or if you are trying to verify proper relay operation, these diagrams should help you.

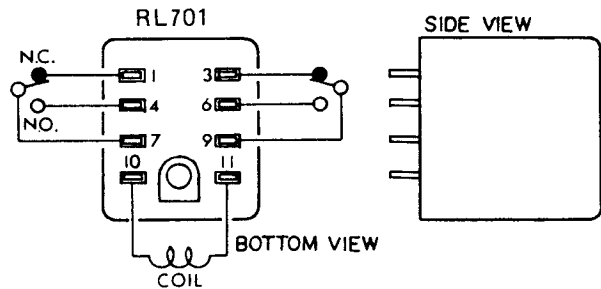

TRANSISTOR & IC PINOUTS

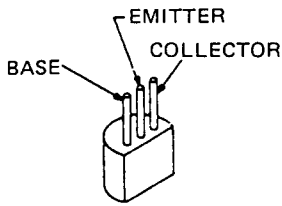

2SC2026

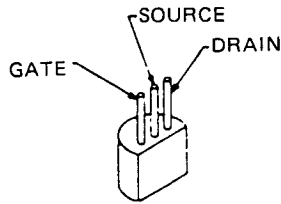

2SK168D

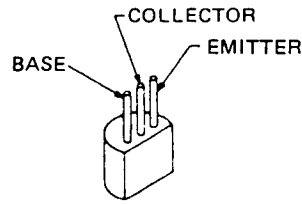

**2SC458B*
2SC1906**

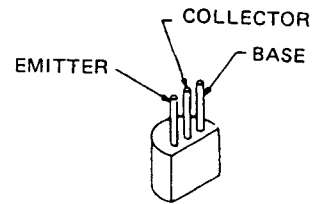

**2SC1209
2SC2053
2SC2538
2SA628**

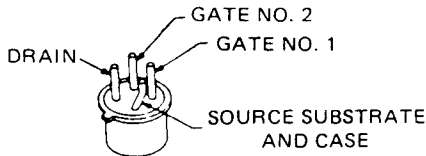

**3SK51
3SK59
3SK60**

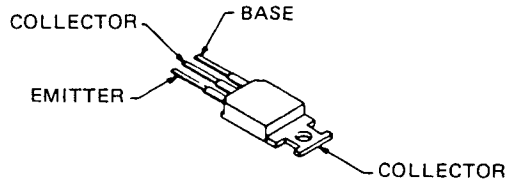

2SB856B

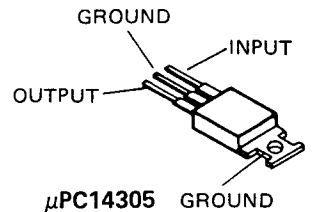

μPC14305

**For Service Manuals Contact
MAURITRON TECHNICAL SERVICES
8 Cherry Tree Rd, Chinnor
Oxon OX9 4QY
Tel:- 01844-351694 Fax:- 01844-352554
Email:- enquiries@mauritron.co.uk**

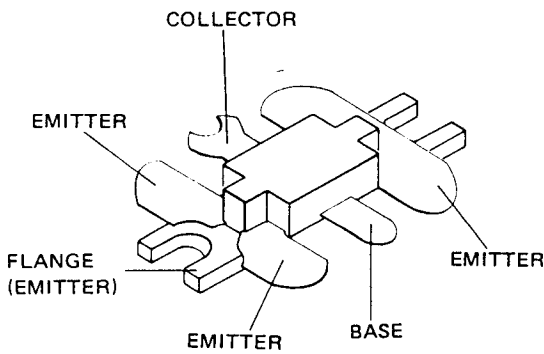

2SC2539

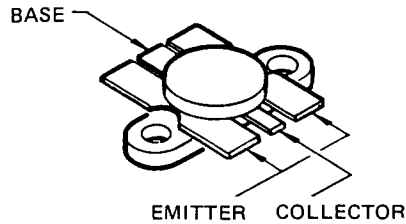

2SC2630

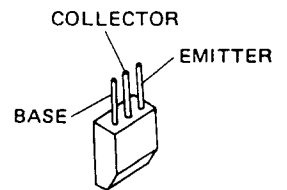

**2SC535A/B
2SC458B*
2SC460B**

PIN 8

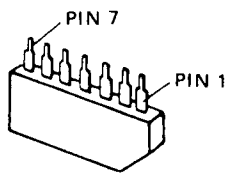

μPC577H

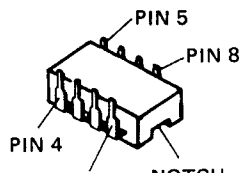

μPB551C

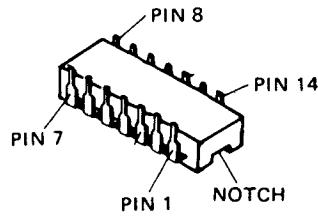

**HD74LS02P
HD74LS74AP**

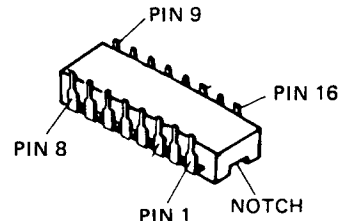

**MC14504B
MC14568B**

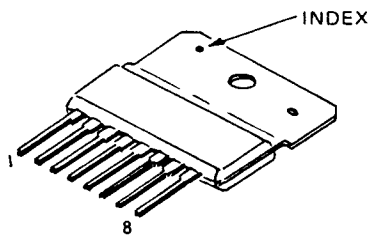

MB3756

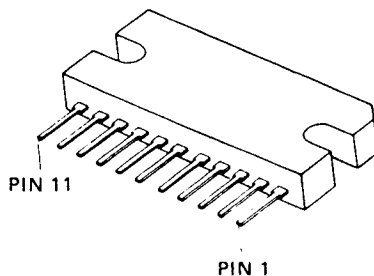

AN315

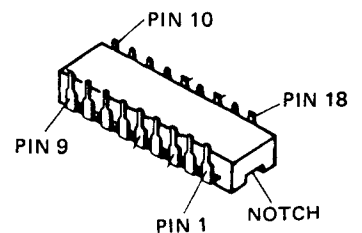

TC9122

LEVEL DIAGRAM

FTC-2640 TRANSMITTER SECTION

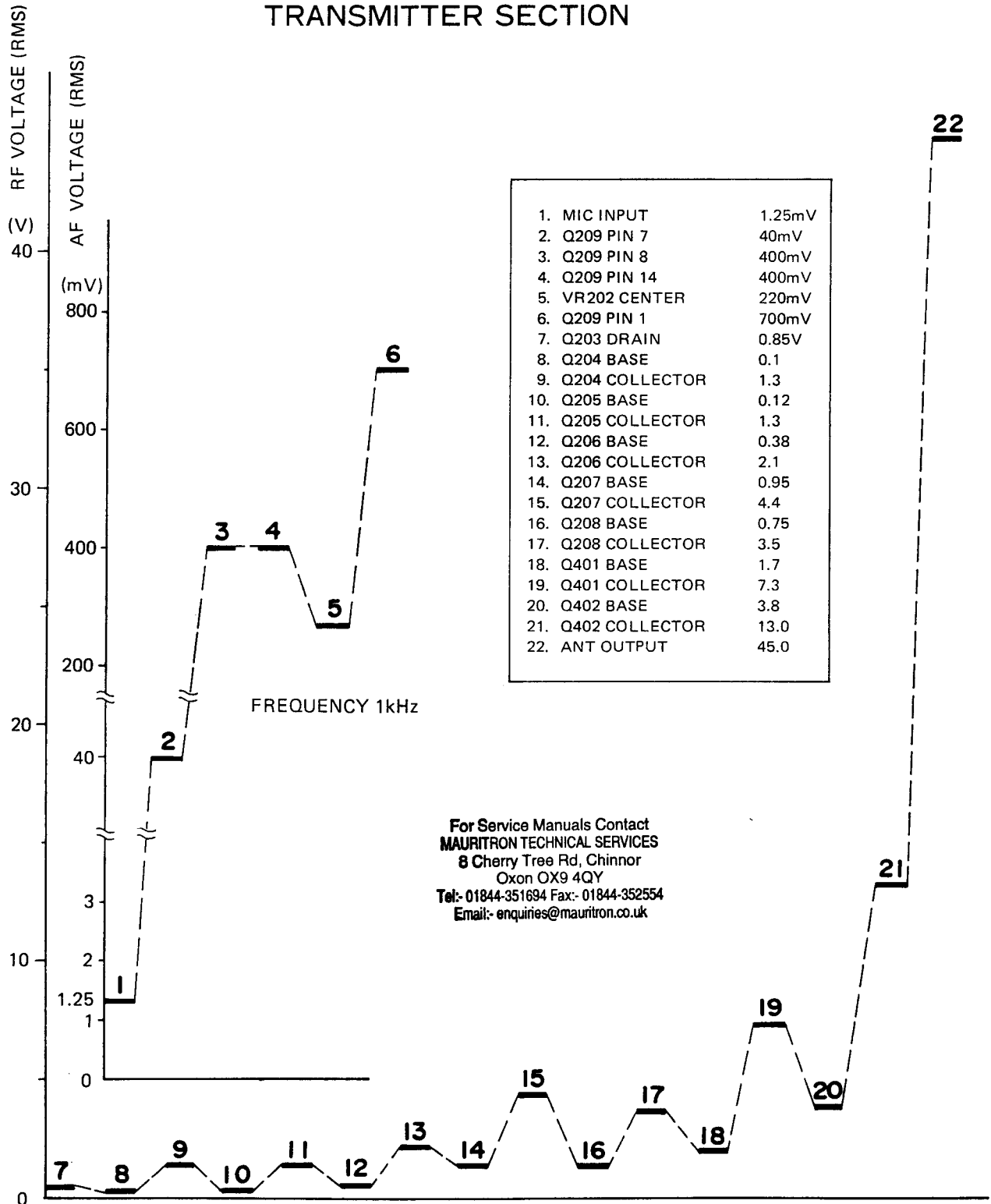

LEVEL DIAGRAM

FTC-2640 RECEIVER SECTION

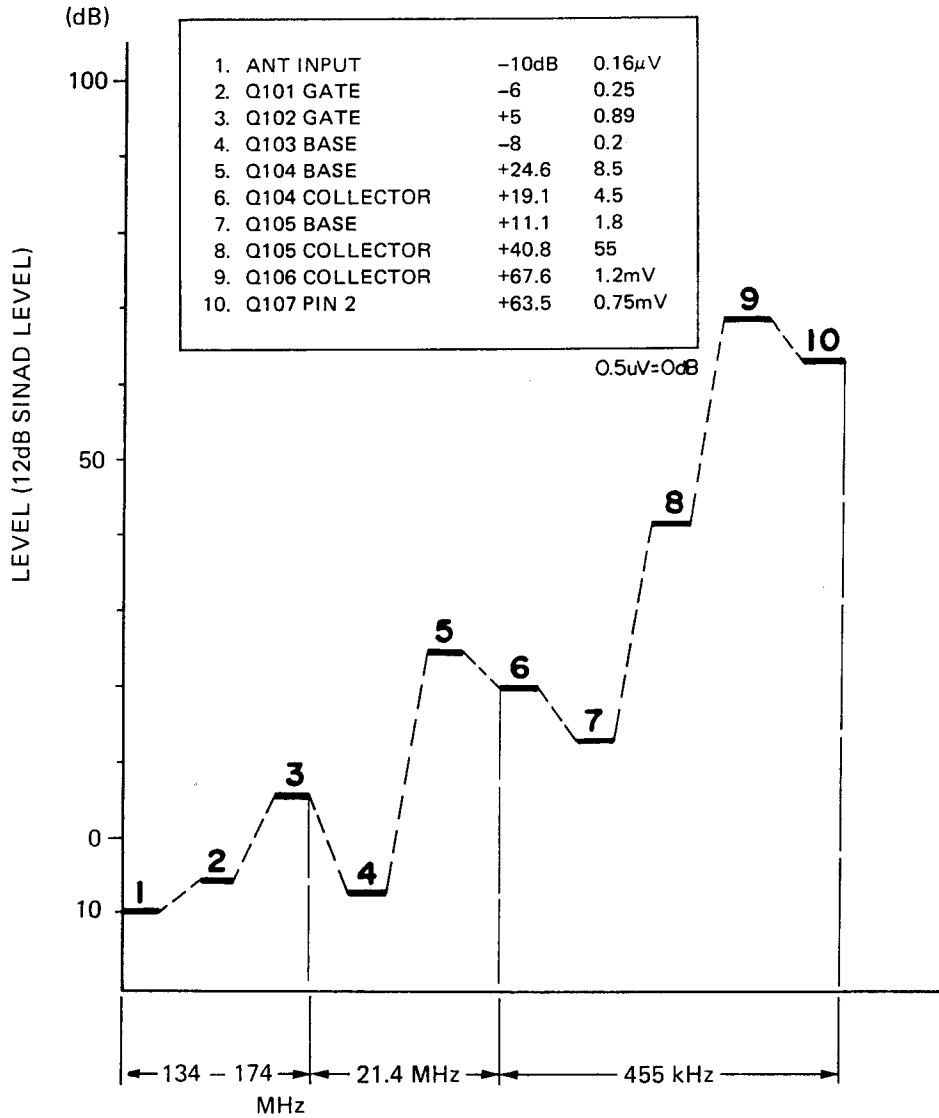

For Service Manuals Contact
MAURITRON TECHNICAL SERVICES
 8 Cherry Tree Rd, Chinnor
 Oxon OX9 4QY
 Tel: 01844-351694 Fax: 01844-352554
 Email: enquiries@mauritron.co.uk

VOLTAGE CHART

	B (G)	E (S)	C (D)	REMARKS		B (G)	E (S)	C (D)	REMARKS
Q101	G ₁ 0.3 V G ₂ 2.0	0.7 V	8.0 V		Q206	0.3 V	0 V	4.4 V	
Q102	G ₁ 0.4 G ₂ 0.9	0.2	2.6		Q207	0.3	0	11.1	
Q103	1.3	0.6	7.4		Q208	0.03	0	13.6	
Q104	1.4	0.7	7.5		Q210	0.1	0	4.7	APC: OPEN
Q105	0.7	0	2.1		Q211	4.7	3.9	8.3	APC: OPEN
Q106	4.8	4.1	6.4		Q213	0.8	0	0.1	APC: OPEN
Q110	1.3	0.7	8.1		Q214	12.7	13.5	13.4	APC: OPEN
Q111	0.7/0.7	0	1.9/1.8	SQ: OFF/ON	Q309	-0.3	0.1	7.9	
Q112	1.9/1.8	1.2/1.1	4.3/4.4	SQ: OFF/ON	Q310	G ₁ 0 G ₂ 4.2	0.4	8.4	
Q113	0.8/1.1	0.1/0.5	0.3/1.8	SQ: OFF/ON	Q311	G ₁ 0 G ₂ 2.7	0.5	7.7	
Q114	0.2/1.2	0.1/0.5	13.2/0.7	SQ: OFF/ON	Q315	3.4	4.1	8.1	
Q115	0.7/0.5	0/0	0.06/12.0	SQ: OFF/ON	Q316	G ₁ 0 G ₂ 2.1	0.3	7.8	
Q116	2.7	2.1	2.9		Q317	G ₁ 0 G ₂ 2.4	0.4	7.8	
Q201	1.9	1.2	8.3		Q401	0	0	13.6	RX
Q202	1.7	0.5	7.3		Q402	0	0	13.6	RX
Q203	G ₁ 0.06 G ₂ 0.3	0.15	8.1			IN	E	OUT	
Q204	0.7	0	6.6		Q312	13.6	0	5.0	
Q205	0.6	0	5.8						

	1	2	3	4	5	6	7	8	9	10	11	12	13	14	REMARKS
Q107	5.3	1.8	1.8	0	6.7	2.9	8.4								
Q108	8.4 /8.4	13.6 /13.5	8.4 /8.4	0/0	13.5 /0.3	8.4 /-0.03	0/0	0.1 /8.4							RX/TX
Q117	5.5 /0.2	0/0	1.2 /0	6.7 /0.2	10.4 /0.2	5.4 /0.2	0/0	5.5 /0.4	5.4 /0.4	13.2 /0.7	13.6 /13.6				SQ: OFF/ON
Q209	4.2	4.2	4.2	8.4	4.2	4.2	4.2	4.3	4.2	4.2	0	4.2	4.2	4.1	
Q212	*	*	*	8.4	*	*	*	4.0	4.0	3.9	0	4.0	3.7	6.8	

Measured with VTVM.

Values are in VOLTS DC.

Q101 ~ Q117 Transmit 0V

Q201 ~ Q214 Receive 0V

For Service Manuals Contact
MAURITRON TECHNICAL SERVICES
 8 Cherry Tree Rd, Chinnor
 Oxon OX9 4QY
 Tel: 01844-351694 Fax: 01844-352554
 Email: enquiries@mauritron.co.uk

SOLDERING AND DESOLDERING TECHNIQUE ON PRINTED CIRCUIT BOARDS

The FTC-2640 circuit boards are tough, but mishandling during soldering can cause circuit traces to "lift." While this does not cause permanent damage to the board, much servicing trouble can result, because of the tendency for this lifted trace to break. A few simple precautions will keep your circuit boards in A-1 condition.

1. Use only a 12 to 30 watt chisel-tip soldering iron. Yes, some "repairmen" have been known to use small blowtorches on cards.
2. Use only a soldering iron equipped with a three-wire cord, with the tip grounded. Also acceptable is a soldering iron isolated through a transformer. An old soldering iron or gun may have 117 volts on the tip, and will certainly cause more damage than it repairs!
3. **USE ONLY 60/40 ROSIN CORE SOLDER.** Acid core solder should be thrown away if you find it in your radio shop!
4. Use a solder sucker and solder tape to ensure a professional repair job.
5. If you do lift a trace, don't worry! Read on to find out how to repair traces like a pro.

NOTES ON USE OF CMOS COMPONENTS:

As CMOS devices are extremely sensitive to damage from static electricity, special precautions must be observed.

In storage, use only sponge specially designed for CMOS components.

When installing a CMOS part in a socket, or on a circuit board, be certain that the power is off. In addition, the technician should rest his hand on the chassis as the component is inserted, so as to place his hand at the same potential as the chassis (better to discharge small amounts of static electricity through your fingers than through a \$5 IC!).

When soldering a CMOS part onto a circuit board, use a low wattage iron, and be sure to ground the tip with a clip lead, if the tip is not grounded through a three-wire power cord.

For Service Manuals Contact
MAURITRON TECHNICAL SERVICES
 8 Cherry Tree Rd, Chinnor
 Oxon OX9 4QY
 Tel:- 01844-351694 Fax:- 01844-352554
 Email:- enquiries@mauritron.co.uk

INSERTION OF PARTS ON CIRCUIT BOARDS

All of the below are acceptable ways of inserting components into circuit board mounting holes.



(a) Bend leads slightly



(b) Straight-in mounting

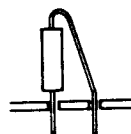

(c) Vertical mounting

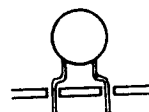

(d) Preformed disc ceramic capacitor



(e) Preformed resistor, diode, etc.

BASIC SOLDERING PRACTICE

EXAMPLES OF POOR SOLDERING PRACTICE

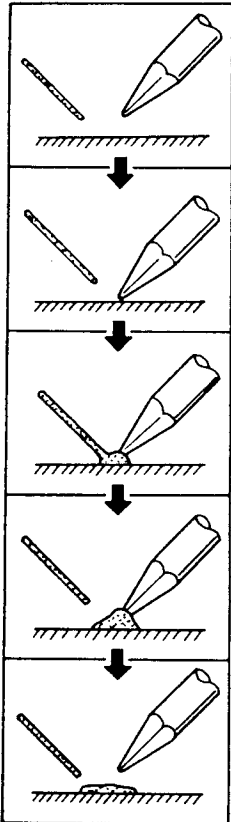

- (1) Prepare soldering iron and solder.
- (2) Apply soldering iron to surface to be soldered.
- (3) Apply solder to heated surface.
- (4) When enough solder is applied, remove solder. Continue to apply heat until solder flows cleanly.
- (5) Remove iron from work. Do not apply more heat than necessary for good solder flow.

Solder bridge (caused by use of too much solder)

"Cold joint" (caused by insufficient heat to part of work, resulting in poor solder flow)

Unstable joint (caused by insufficient heat or solder)

For Service Manuals Contact
MAURITRON TECHNICAL SERVICES
 8 Cherry Tree Rd, Chinnor
 Oxon OX9 4QY
 Tel: 01844-351694 Fax: 01844-352554
 Email: enquiries@mauritron.co.uk

Soldering to terminal posts:

(Be certain to apply heat to both post and wire.)

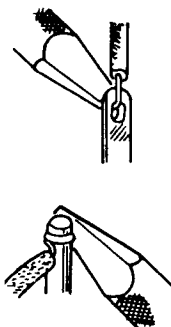
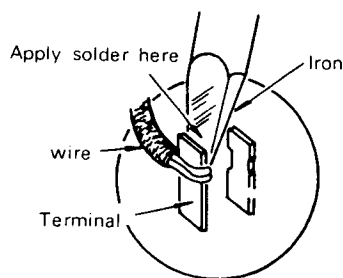

If you have previously lifted a trace, make an etch cut on each side of the lifted trace, and install a wire bridge as shown in the drawing.

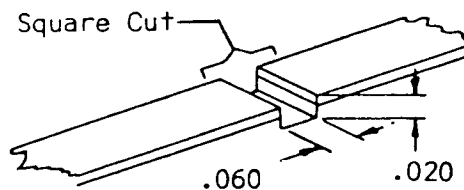
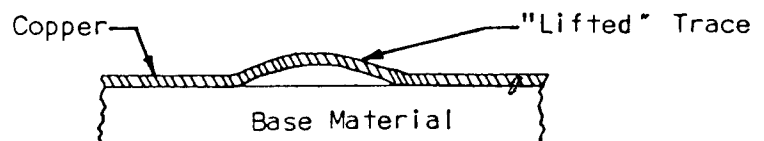

Coat Cut Area With Eastman 910

FAULT LOCALIZATION

While the process of fault localization is highly individualistic, it is generally agreed that there is no substitute for a logical, step-by-step diagnostic check.

Begin your troubleshooting procedure with a visual inspection of the radio. Use your nose, too: burned resistors smell differently than do transformers, etc. Check for charred or loose components inside the cabinet.

If the preliminary inspection turns up nothing, connect a dummy load to the antenna jack, and a 13.6 VDC bench supply to the power cord. The supply should be capable 8 amperes continuous for the FTC-2640.

Turn the power switch on, and begin a systematic check. Do the lamps light up? If not, check the fuse. Is the trouble not apparent? Perhaps it only happens on transmit. Check for noises, pops, sparks, or smoke inside the cabinet – these are unmistakable declarations by the radio that something is awry!

TYPICAL PART FAILURES, CAUSES, AND SYMPTOMS

PARTS	CAUSE OF TROUBLE	SYMPTOMS
Semiconductors (IC, FET, TR)	High supply voltage Open circuit Excessive drive High temperature	Short or open circuit Output decreases to 1/2 at 80°C Internal noise Instability
MOS FET MOS IC	Static electricity	Total failure
Crystal Crystal filter	Shock High temperature	Crystal destroyed Frequency drift Filter bandpass change
Resistor	Excessive power Aging High temperature	Component burned Value changed Open circuit
Potentiometer	Excessive power Shock	Component burned Open circuit Noise Unsmooth rotation
Capacitor	Excess voltage High temperature Excess power	Shorted Leakage Open/decreased capacitance
Variable capacitor Trimmer capacitor	Ratings exceeded Dust between plates Shock, forced rotation	Shorted Leakage Unsmooth rotation
Coils	Ratings exceeded Variation	Open or short circuit Leakage or shorted turns Detuned
Switch	Ratings exceeded Aging	Poor contact Unsmooth operation Open circuit
Relay	Ratings exceeded Humidity	Poor contact Noise Coil open

For Service Manuals Contact
MAURITRON TECHNICAL SERVICES
8 Cherry Tree Rd, Chinnor
Oxon OX9 4QY
Tel: 01844-351694 Fax: 01844-352354
Email: enquiries@mauritron.co.uk

MAINTENANCE AND SERVICING

REGULAR MAINTENANCE PLAN

Because of the rugged design and construction of the FTC-2640, little maintenance should be required if the radio is not abused. As a Yaesu dealer, though, you are best in a position to determine the individual needs of your customers. Operation in extremely harsh environments may warrant more frequent checks of transceiver performance.

We recommend that your customers return their sets to your service facility once every two years for routine checks of the transmitter power output and the receiver sensitivity. In the meantime, keep in frequent touch with your customers regarding their expanding communications requirements. Not only will this give you the opportunity to introduce new Yaesu products, but your customers' particular service requirements will become evident.

PERFORMANCE CHECKS

Make all performance checks at 13.6 volts DC under load.

Check the transmitter power output as follows:

- Connect a suitable dummy load/wattmeter to the antenna jack.
- Set the channel selector to any channel. Close the push-to-talk switch, and observe the power output. The output should be at least 40 watts.

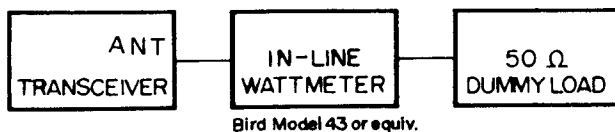

PO TEST SETUP

Check the receiver sensitivity as follows:

- Connect an 8 ohm dummy load and a SINAD meter to the SP jack. Set the SQUELCH control fully counterclockwise.
- Connect the RF output of a precision VHF signal generator to the antenna jack, and set the output to 1 mV with 60% deviation at 1 kHz. Adjust the VOLUME Control to 150 mW AF output.
- Now reduce the output of the signal generator to the point where the deflection of the SINAD meter indicates 12 dB. Check to see that the signal generator reads 12 dB SINAD sensitivity. The nominal value of the output from the signal generator should be approximately 0.35 μ V.

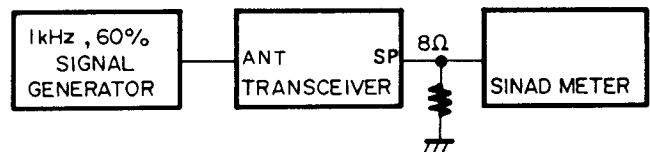

RX SENSITIVITY TEST SETUP

If the above checks are both OK, then clean out the transceiver by applying moderate-force compressed air throughout the chassis area. This will remove any dust that may be present. If there is accumulated dirt inside the cabinet, a soft brush may be used to loosen it. Wipe the outer cabinet of the transceiver with a damp cloth, and use the compressed air to dislodge accumulated dust present in the corners of the radio.

For Service Manuals Contact
MAURITRON TECHNICAL SERVICES
8 Cherry Tree Rd, Chinnor
Oxon OX9 4QY
Tel:- 01844-351694 Fax:- 01844-352554
Email:- enquiries@mauratron.co.uk

ALIGNMENT

Internal adjustments should, under most circumstances, be limited to those described in the paragraphs to follow.

Remove the four screws from the top cover, then the four screws from the bottom cover, in order to provide full access to the transceiver circuitry.

For Service Manuals Contact
MAURITRON TECHNICAL SERVICES
 8 Cherry Tree Rd, Chinnor
 Oxon OX9 4QY
Tel:- 01844-351694 Fax:- 01844-352554
Email:- enquiries@mauritron.co.uk

RECOMMENDED ALIGNMENT EQUIPMENT

Frequency Counter (8-digit, ±0.02 PPM)	YC-500E (Yaesu), or equivalent
DC Voltmeter	HP 4304B (Hewlett-Packard)
VTVM with 500 MHz RF Probe	HP 3406A " "
Sweep Generator	HP 8620 " "
Spectrum Analyzer	HP 141T, 8552B, or 8554B (Hewlett-Packard) " "
Standard Signal Generator	HP 8640B " "
AF VTVM	HP 400E " "
Distortion Meter	HP 334A " "
SINAD Meter	S101 (Helper Instr. Co.) " "
X-Y Oscilloscope	HP 1222A (Hewlett-Packard) " "
In-line Wattmeter	Bird 43 " "
Power Attenuator (20dB)	Bird 8343-200 " "
Attenuator (20dB)	HP 8491A (Hewlett-Packard) " "
Linear Detector	HP 8901A " "
Audio Generator	HP 200CD " "

ALIGNMENT FREQUENCIES AND MATRIX PROGRAMMING CHART

CH	BAND A 134-143.995MHz	BAND C 154-163.995MHz	COLUMN POSITION (DIODE) NO.														
			14	13	12	11	10	9	8	7	6	5	4	3	2	1	T
F 1	143.500MHz	163.500MHz	0	0	0	0	0	1	1	0	0	1	0	1	0	1	1
F 2	134.500	154.500	0	0	0	0	0	1	0	0	0	0	0	1	0	1	1
F 3	139.500	159.500	0	0	0	0	0	1	0	1	0	1	0	1	0	1	1
F 4	139.000	159.000	0	0	0	0	0	1	0	1	0	1	0	0	0	0	1
F 5	139.995	159.995	1	1	0	0	1	1	0	1	0	1	1	0	0	1	1
F 6	143.995	163.995	1	1	0	0	1	1	1	0	0	1	1	0	0	1	1
F 7	143.000	163.000	0	0	0	0	0	1	1	0	0	1	0	0	0	0	1
F 8	134.000	154.000	0	0	0	0	0	1	0	0	0	0	0	0	0	0	1

CH	BAND A*	BAND C*	COLUMN POSITION (DIODE) NO.														
			14	13	12	11	10	9	8	7	6	5	4	3	2	1	
F 1	143.800MHz	163.800MHz	0	0	1	0	0	1	1	0	0	1	0	1	0	1	1
F 2	134.800	154.800	0	0	1	0	0	1	0	0	0	0	0	1	0	1	1
F 3	139.800	159.800	0	0	1	0	0	1	0	1	0	1	0	1	0	1	1
F 4	139.300	159.300	0	0	1	0	0	1	0	1	0	1	0	0	0	0	1
F 5	140.2875	160.2875	1	1	0	0	0	1	0	1	0	1	1	0	0	1	1
F 6	144.2875	164.2875	1	1	0	0	0	1	1	0	0	1	1	0	0	1	1
F 7	143.300	163.300	0	0	1	0	0	1	1	0	0	1	0	0	0	0	1
F 8	134.300	154.300	0	0	1	0	0	1	0	0	0	0	0	0	0	0	1

CH	BAND B 144-153.995MHz	BAND D 164-173.995MHz	COLUMN POSITION (DIODE) NO.														
			14	13	12	11	10	9	8	7	6	5	4	3	2	1	T
F 1	153.500MHz	173.500MHz	0	0	0	0	0	0	1	0	0	1	0	1	0	1	1
F 2	144.500	164.500	0	0	0	0	0	0	0	0	0	0	0	1	0	1	1
F 3	149.500	169.500	0	0	0	0	0	0	0	1	0	1	0	1	0	1	1
F 4	149.000	169.000	0	0	0	0	0	0	0	1	0	1	0	0	0	0	1
F 5	149.995	169.995	1	1	0	0	1	0	0	1	0	1	1	0	0	1	1
F 6	153.995	173.995	1	1	0	0	1	0	1	0	0	1	1	0	0	1	1
F 7	153.000	173.000	0	0	0	0	0	0	1	0	0	1	0	0	0	0	1
F 8	144.000	164.000	0	0	0	0	0	0	0	0	0	0	0	0	0	0	1

CH	BAND B*	BAND D*	COLUMN POSITION (DIODE) NO.														
			14	13	12	11	10	9	8	7	6	5	4	3	2	1	
F 1	153.800MHz	173.800MHz	0	0	1	0	0	0	1	0	0	1	0	1	0	1	1
F 2	144.800	164.800	0	0	1	0	0	0	0	0	0	0	0	0	1	0	1
F 3	149.800	169.800	0	0	1	0	0	0	0	1	0	1	0	1	0	1	1
F 4	149.300	169.300	0	0	1	0	0	0	0	1	0	1	0	0	0	0	1
F 5	150.2875	170.2875	1	1	0	0	0	0	0	1	0	1	1	0	0	1	1
F 6	154.2875	174.2875	1	1	0	0	0	0	1	0	0	1	1	0	0	1	1
F 7	153.300	173.300	0	0	1	0	0	0	1	0	0	1	0	0	0	0	1
F 8	144.300	164.300	0	0	1	0	0	0	0	0	0	0	0	0	0	0	1

CH	BAND E 150-159.995MHz	COLUMN POSITION (DIODE) NO.														
		14	13	12	11	10	9	8	7	6	5	4	3	2	1	T
F 1	159.500MHz	0	0	0	0	0	1	0	1	1	0	1	0	1	1	1
F 2	150.500	0	0	0	0	0	0	1	0	0	0	0	1	0	1	1
F 3	155.500	0	0	0	0	0	1	0	0	1	1	0	1	0	1	1
F 4	155.000	0	0	0	0	0	1	0	0	1	1	0	0	0	0	1
F 5	155.995	1	1	0	0	1	1	0	0	1	1	1	0	0	1	1
F 6	159.995	1	1	0	0	1	1	0	1	1	1	1	0	0	1	1
F 7	159.000	0	0	0	0	0	1	0	1	1	1	0	0	0	0	1
F 8	150.000	0	0	0	0	0	0	1	0	0	0	0	0	0	0	1

CH	BAND E*	COLUMN POSITION (DIODE) NO.														
		14	13	12	11	10	9	8	7	6	5	4	3	2	1	
F 1	159.800MHz	0	0	1	0	0	1	0	1	1	1	0	1	0	1	1
F 2	150.800	0	0	1	0	0	0	1	0	0	0	0	1	0	1	1
F 3	155.800	0	0	1	0	0	1	0	0	1	1	0	1	0	1	1
F 4	155.300	0	0	1	0	0	1	0	0	1	1	0	0	0	0	1
F 5	156.2875	1	1	0	0	0	1	0	0	1	1	1	0	0	1	1
F 6	160.2875	1	1	0	0	0	1	0	1	1	1	1	0	0	1	1
F 7	159.300	0	0	1	0	0	1	0	1	1	1	0	0	0	0	1
F 8	150.300	0	0	1	0	0	0	1	0	0	0	0	0	0	0	1

1. PLL CIRCUIT

Alignment frequencies (F1 through F8) are shown in the Chart on Page 3-16. Use an Alignment Matrix programmed for these frequencies when performing alignment. Alignment points are illustrated on Page 3-18.

A. PLL VCV (Varactor Control Voltage)

- 1) Connect the DC voltmeter to the high end of R₃₁₀.
- 2) Set the Channel Selector to F1 and adjust T₃₀₁ for 4V on the meter.
- 3) Set the Channel Selector to F2 and adjust VR₃₀₁ for 4V on the meter, and then check the DC voltage across C₃₄₇ for at least 2V.
- 4) Reconnect the meter to R₃₁₀ and set the Channel Selector to each of positions F3 through F8 while checking to see that the voltage at R₃₁₀ remains between 2 and 6V.

B. PLL Frequency

- 1) Connect the frequency counter to TP₂₀₄ and set the Channel Selector to F4.
- 2) Adjust TC₃₀₁ for a frequency of *f_{PLL} ± 50 Hz.

*f _{PLL} — BAND (A)	117.6 MHz
BAND (B)	127.6 MHz
BAND (C)	137.6 MHz
BAND (D)	147.6 MHz
BAND (E)	133.6 MHz

C. PLL Level

- 1) Connect the RF probe of the voltmeter to TP₂₀₄.
- 2) With the Channel Selector set to F1, F2 and F3 check that more than 0.3V (+2.5 dBm) is shown on the meter.

For Service Manuals Contact
MAURITRON TECHNICAL SERVICES
 8 Cherry Tree Rd, Chinnor
 Oxon OX9 4QY
 Tel:- 01844-351694 Fax:- 01844-352554
 Email:- enquiries@mauritron.co.uk

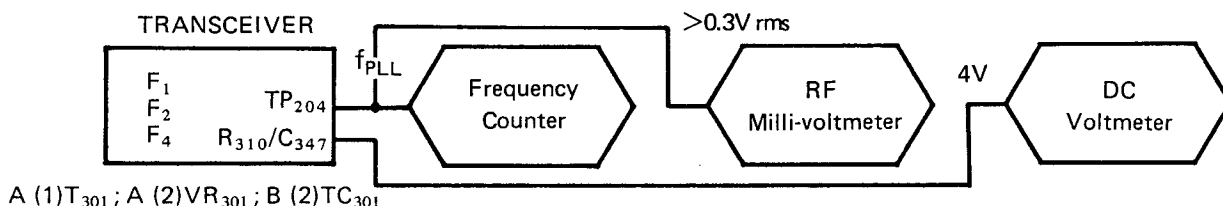

2. TRANSMITTER CIRCUITS

Alignment points are illustrated on Page 3-20.

A. 21.4 MHz Oscillator

- 1) Connect both the frequency counter and the RF probe of the voltmeter to TP₂₀₃, and the 50 ohm dummy load to J₂₀₁ after removing plug P₄₀₁.
- 2) Adjust VR₂₀₁ for a frequency of 21.4 MHz ± 10 Hz on the counter. (If the signal level at TP₂₀₃ is insufficient, perform the following step first.)
- 3) Adjust T₂₀₂ and T₂₀₃ for a maximum reading on the voltmeter (approx. 250 mV).

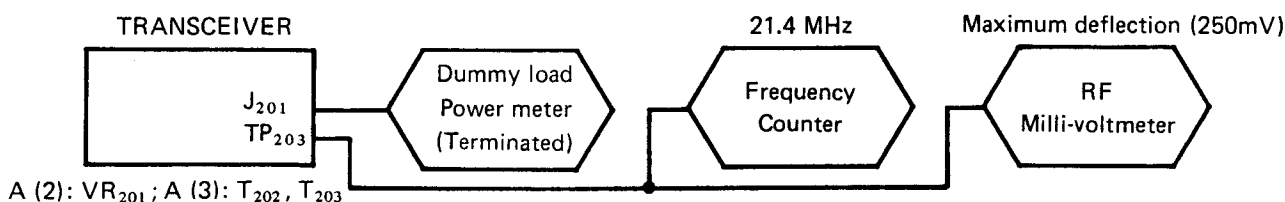

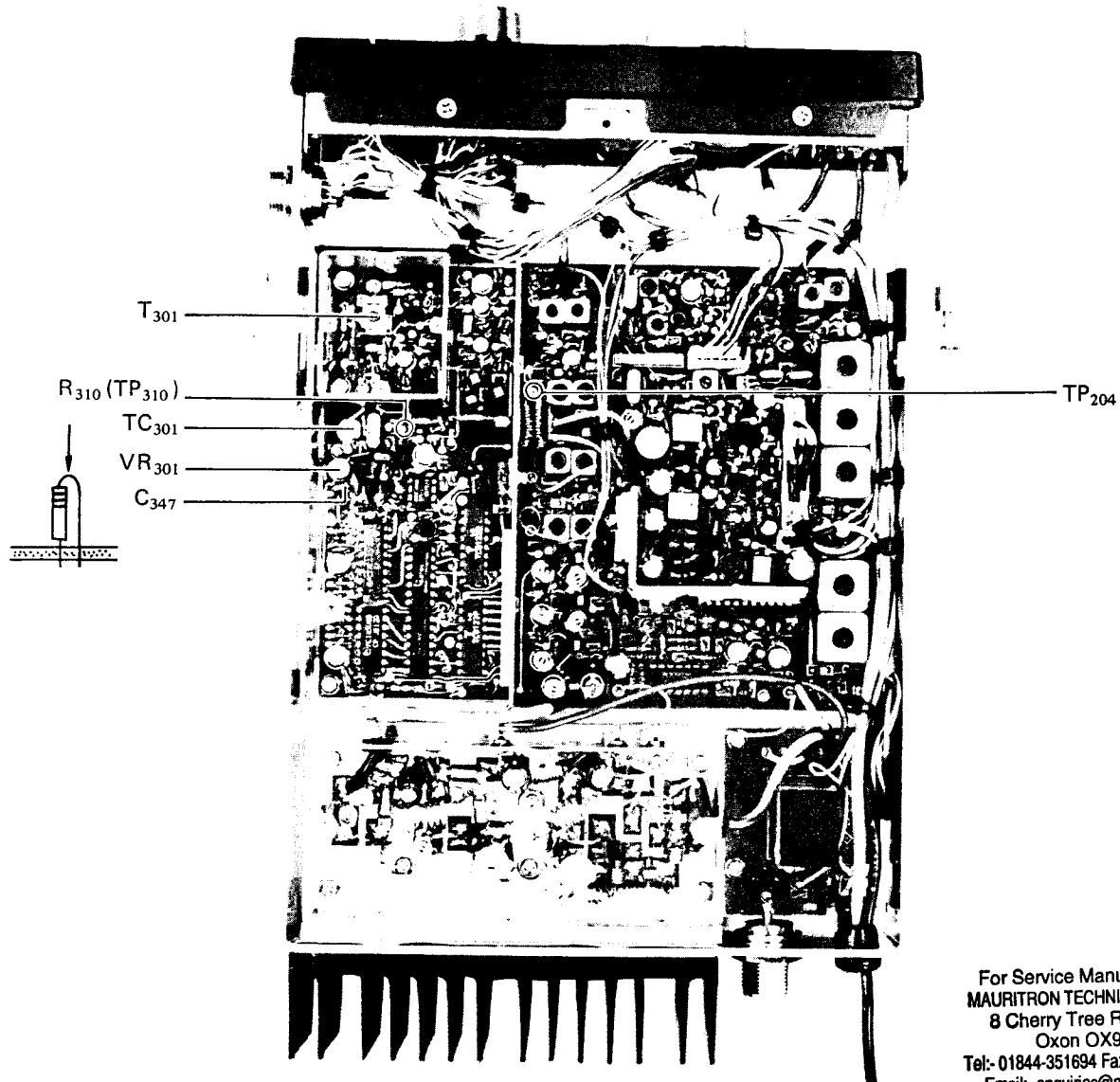

For Service Manuals Contact
MAURITRON TECHNICAL SERVICES
 8 Cherry Tree Rd, Chinnor
 Oxon OX9 4QY
 Tel:- 01844-351694 Fax:- 01844-352554
 Email:- enquiries@mauritron.co.uk

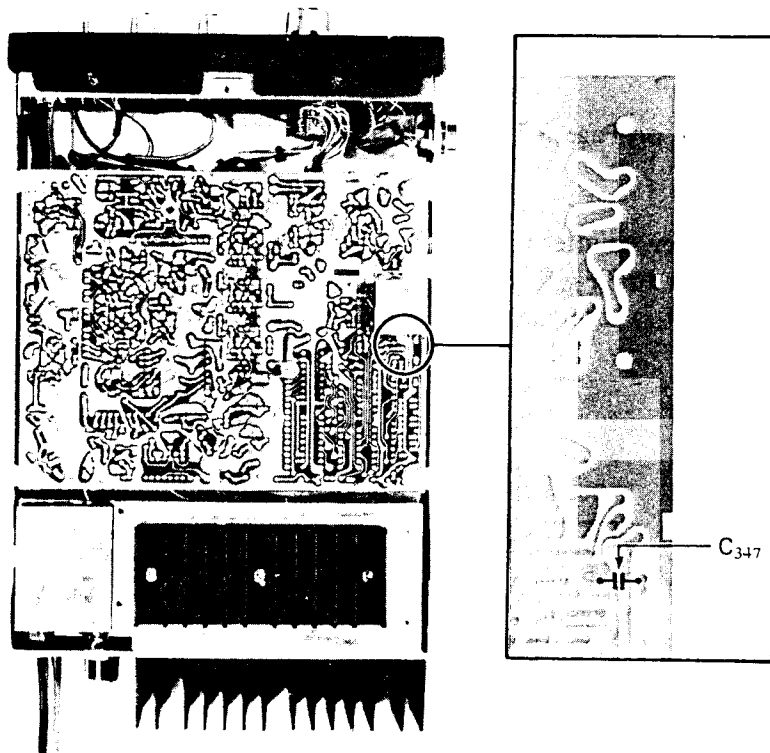

PLL SECTION ALIGNMENT POINTS

B. Auto Tune

- 1) Connect the Sweep Generator to TP₂₀₃, the oscilloscope through a detector to TP₂₀₅, and the 50 ohm dummy load to J₂₀₁ (P₄₀₁ removed).
- 2) Short across the terminals of R₃₈₉ and L₂₀₆ to unlock the VCO, in order to provide a clear scope pattern during the following steps.
- 3) Set the Channel Selector to F1 and depress the PTT switch.
- 4) Adjust T₂₀₄ through T₂₀₉ to obtain a sharp peak on the pattern shown at the right at $f_0 (= f_{max} - 0.5 \text{ MHz})$.

- 5) Switch the Channel Selector to F2 and adjust VR₃₀₃ for the peak at $f_0 (= f_{min} + 0.5 \text{ MHz})$.
- 6) Check that the voltage across C₃₇₃ is more than 2V.

For Service Manuals Contact
MAURITRON TECHNICAL SERVICES
 8 Cherry Tree Rd, Chinnor
 Oxon OX9 4QY
 Tel:- 01844-351694 Fax:- 01844-352554
 Email:- enquiries@mauritron.co.uk

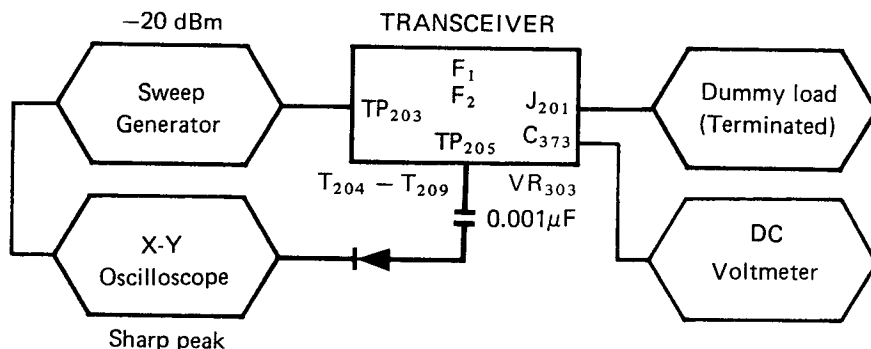
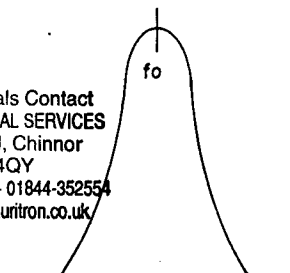

C. Exciter

- 1) Connect the sweep generator through a 1000pF capacitor to TP₂₀₅, and the in-line wattmeter (1 or 5 watts) to J₂₀₁, and to a 30 dB attenuator to a detector and the oscilloscope.
- 2) Connect a 1000pF capacitor across the terminals of T₂₀₉.
- 3) Preset VR₂₆₃ fully clockwise (maximum), set the sweep generator output level to 0 dBm, and adjust TC₂₀₁ through TC₂₀₆ for a flat top on the scope pattern at $f_c \pm 5 \text{ MHz}$ as shown in the Figure.
- 4) Now gradually vary the sweep generator output level from 0 to -10 dBm while watching the waveform to check that the amplitude varies smoothly.

- 5) Disconnect the sweep generator and the 1000pF capacitors, and check that the wattmeter shows at least 0.3 watts in all channels (F1 through F8).

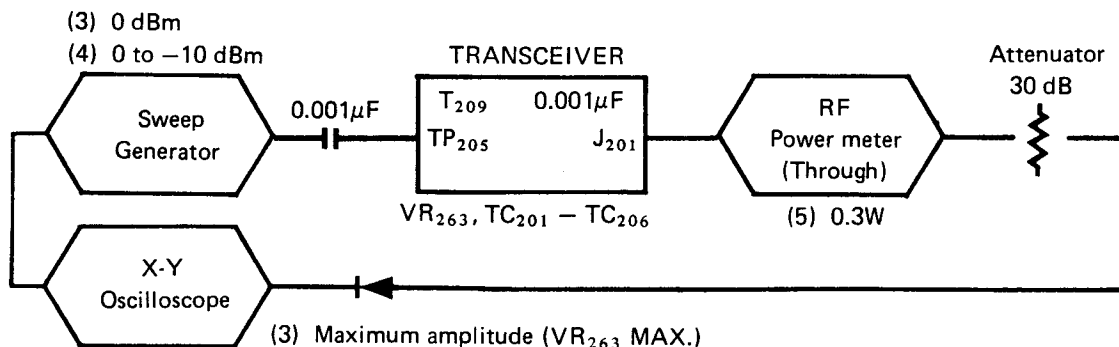
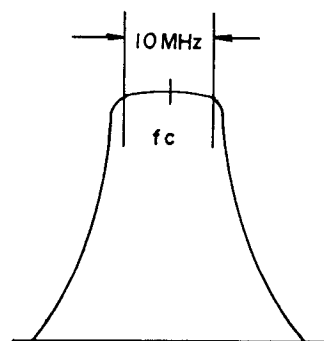

For Service Manuals Contact
MAURITRON TECHNICAL SERVICES
 8 Cherry Tree Rd, Chinnor
 Oxon OX9 4QY
 Tel:- 01844-351694 Fax:- 01844-352554
 Email:- enquiries@mauritron.co.uk

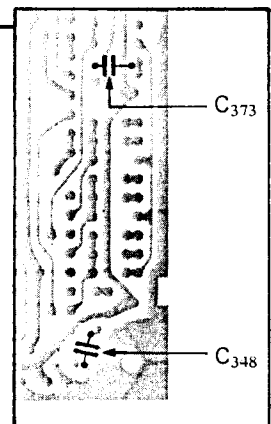
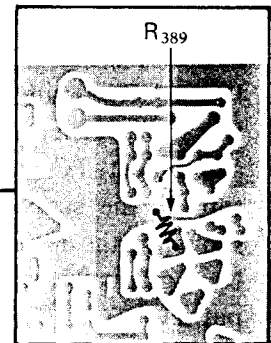
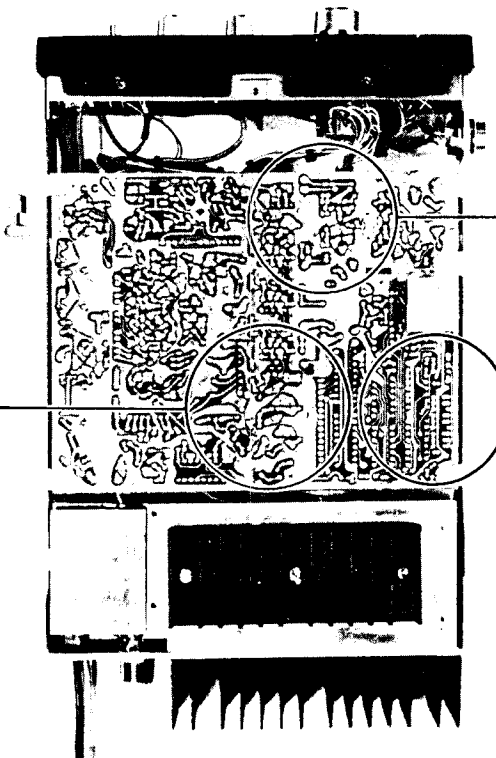
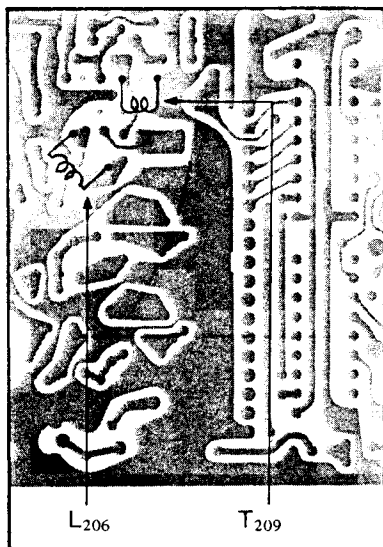
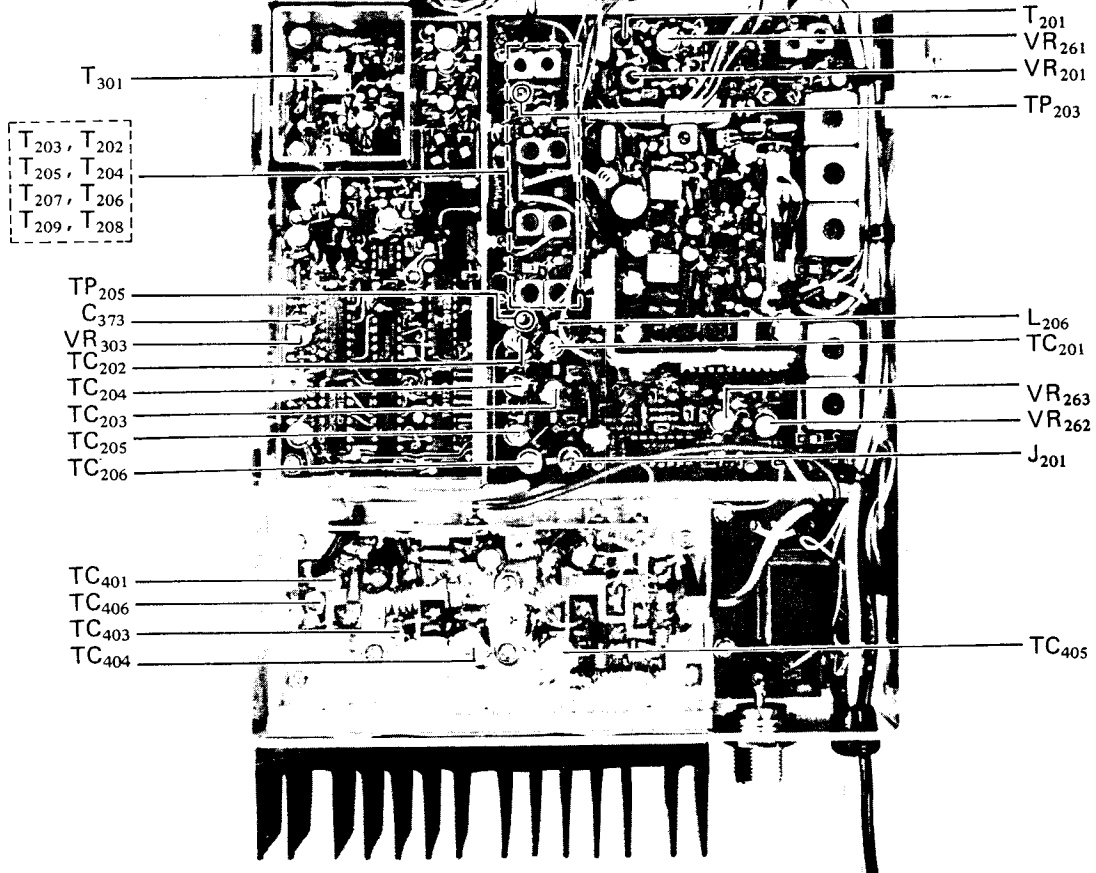

TRANSMITTER SECTION ALIGNMENT POINTS

D. Power Amplifier

- 1) Connect the in-line wattmeter (50 watts) to the ANT terminal and to the 30 dB attenuator to the diode detector to the oscilloscope. Connect the sweep generator through a 1000pF capacitor to TP₂₀₅ and another 1000pF capacitor across T₂₀₉ as in the previous Exciter alignment.
- 2) Preset VR₂₆₂ fully counter-clockwise, VR₂₆₃ fully clockwise and the sweep generator output level to 0 dBm.
- 3) Adjust TC₄₀₁ through TC₄₀₆ to obtain at least 40 watts output through the 10 MHz range of the transceiver ($f_c \pm 5$ MHz) with a smooth, symmetrical curve peaking at f_c , as illustrated. DO NOT PEAK power output at one frequency, since the trimmer capacitors in the final amplifier may be destroyed.

- 4) Vary the supply voltage between 10 and 16.5V while also varying the sweep generator output level between 0 and -10 dBm. Ensure that the power output changes smoothly during these variations.
- 5) Remove the sweep generator and the 1000pF capacitors and check that the output is at least 40 watts in all channels (F1 through F8).

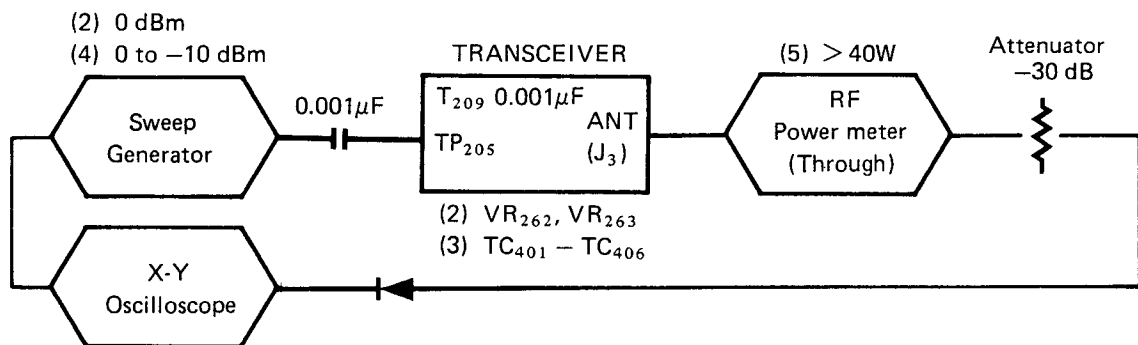
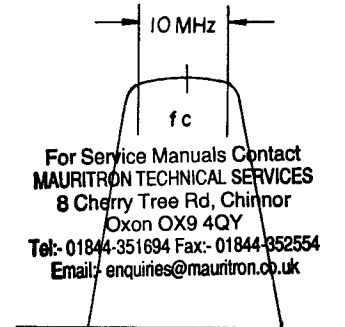

E. APC (Automatic Power Control) and AFP (Automatic Final Protection)

- 1) Connect the dummy load and wattmeter (50 watts) to the ANT terminal and the DC ammeter in the DC supply line.
- 2) Set the Channel Selector to F4 (the center of the band).
- 3) Adjust VR₂₆₃ for 40 watts on the wattmeter, and check channels F1 and F2 for 40 watts ± 3 watts.

- 4) Rotate VR₂₆₂ clockwise just to the point where output power begins to decrease, and then rotate it back 30 degrees counter-clockwise from this point. If output power does not decrease at any point, set VR₂₆₂ fully clockwise.
- 5) Remove the dummy load and briefly depress the PTT switch. Check that the total DC current is less than 5A.

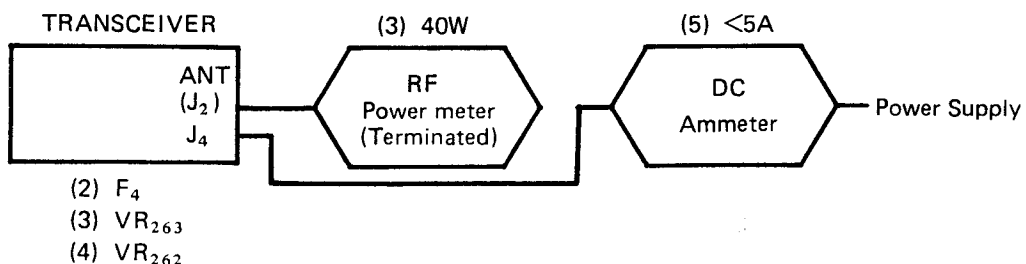

F. Spurious Check with Supply Voltage Variation

- 1) Connect the in-line wattmeter (50 watts) to the spectrum analyzer (through an attenuator) and to the ANT terminal. Connect the DC voltmeter so as to measure the supply voltage.
- 2) First in channel F1, vary the supply voltage over the range of $13.6V \pm 15\%$ while ensuring

that spurious radiation is below -60 dB from the output power level.

- 3) Repeat the previous step for channels F2 and F3, and adjust T_{202} and T_{203} if spurious radiation exceeds -60 dB.

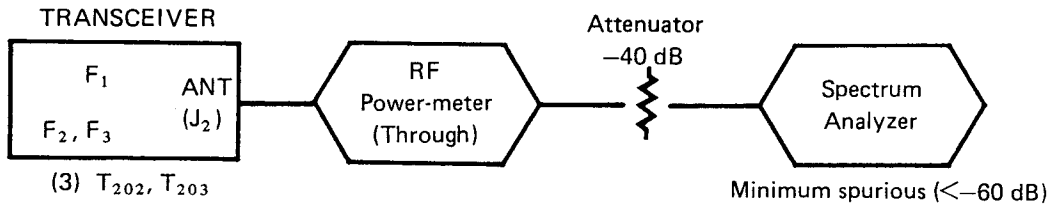

For Service Manuals Contact
MAURITRON TECHNICAL SERVICES
 8 Church Tree Rd, Chalfont
 Oxon OX9 4QY
 Tel:- 01844-351694 Fax:- 01844-352554
 Email:- enquiries@mauritron.co.uk

G. Modulation and Deviation

- 1) Connect the audio generator and level meter to pin 6 of MIC jack J_1 , and the in-line wattmeter with 40 dB power attenuator to the ANT terminal. Connect the deviation meter and distortion meter with level meter to the attenuator output.
- 2) Set the Channel Selector to F3 and the audio generator output level to -40 dBm at 1 kHz.
- 3) Adjust VR_{261} , if necessary, to obtain ± 4.9 kHz (± 2.45 kHz) deviation on the meter, and then check that the deviation remains under ± 5 kHz (± 2.5 kHz) while varying the audio generator output from 300 to 3000 Hz.
- 4) Reduce the audio generator input level so that the deviation meter indicates $3(\pm 1.5)$ kHz deviation (1 kHz audio frequency), and check that the audio input level is -61 dBm ± 3 dB.

- 5) Check that the THD is less than 7% and the S/N less than -40 dB.
- 6) Now reduce the audio generator output level 15 dB from -61 dBm (-76 dBm). While tuning the audio frequency from 300 to 15000 Hz observe that the deviation remains constant as the level meter shows the following values:

0.3 kHz	-10.5 dB	+1 -3 dB
1 kHz	0 dB	
3 kHz	+9.5 dB	+1 -4.5 dB
15 kHz	-25 dB or less	

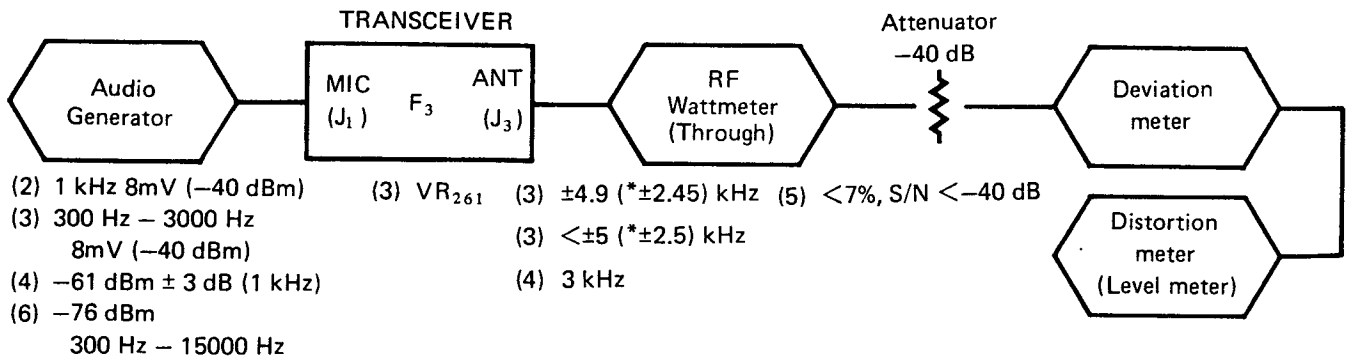

- (1) 1 kHz 8mV (-40 dBm)
- (2) 300 Hz - 3000 Hz 8mV (-40 dBm)
- (3) -61 dBm ± 3 dB (1 kHz)
- (4) -76 dBm 300 Hz - 15000 Hz
- (5) $<7\%$, S/N <-40 dB
- (6) 3 kHz

* 12.5 kHz/step model

3. RECEIVER CIRCUITS

Alignment points are illustrated on Page 3-24.

A. First Local PLL

- 1) Connect the RF probe of the voltmeter to gate two of Q₁₀₂. Set the Channel Selector to F3.
- 2) Adjust T₁₀₉, T₁₁₀ and TC₃₀₂ located in the PLL shield case for a maximum deflection on the voltmeter (about 1.0Vrms).
- 3) Check that the signal level at gate two of Q₁₀₂ is at least 1 volt in channel positions F1, F2 and F3.

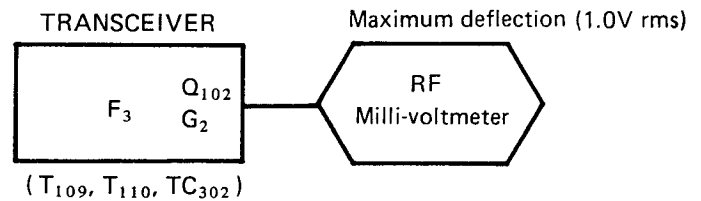

B. Second Local

- 1) Connect the frequency counter through a 1000pF capacitor to the base of Q₁₀₄ (2SC535B).
- 2) Adjust TC₁₀₁ if necessary to achieve a reading of 20.945 MHz ± 20 Hz on the counter.

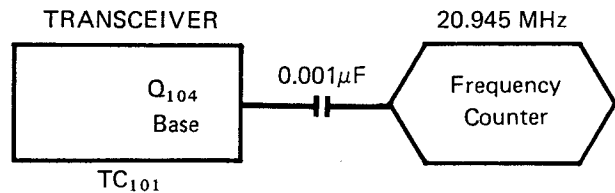

C. Sensitivity

- 1) Connect the SSG (standard signal generator) to the ANT terminal, and an 8 ohm, 5 watt resistor across EXT SP jack J₂. Connect the distortion meter and level meter to the EXT SP jack.
- 2) Set the Channel Selector to F1, and tune the SSG to the F1 receive frequency with 60% modulation at 1 kHz.
- 3) Adjust the SSG output level to obtain a 12 to 15 dB reading on the distortion meter, and then adjust L₁₀₁ through L₁₀₅ and T₁₀₇ for minimum distortion on the meter. Now adjust T₁₀₈ for maximum indication on the level meter.

- 4) Again adjust the SSG output level to obtain 12 dB of distortion, and check that the SSG level is less than 0.32 µV (-4 dBµ).
- 5) Set the Channel Selector to F2 and repeat the SSG set up procedure in steps 2 and 3, adjusting VR₃₀₂ on the PLL unit for minimum distortion on the meter.
- 6) Check that the voltage across C₃₄₈ on the PLL unit is less than 2V.
- 7) Set the Channel Selector to F4 (band center +0.5 MHz) and check sensitivity, then repeat the check for F5 (band center -0.5 MHz).

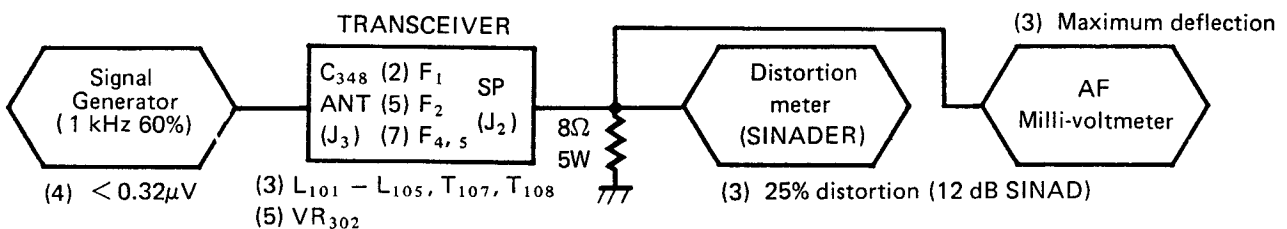

For Service Manuals Contact
MAURITRON TECHNICAL SERVICES
 8 Cherry Tree Rd, Chinnor
 Oxon OX9 4QY
 Tel: 01844-351694 Fax: 01844-352554
 Email: enquiries@mauritron.co.uk

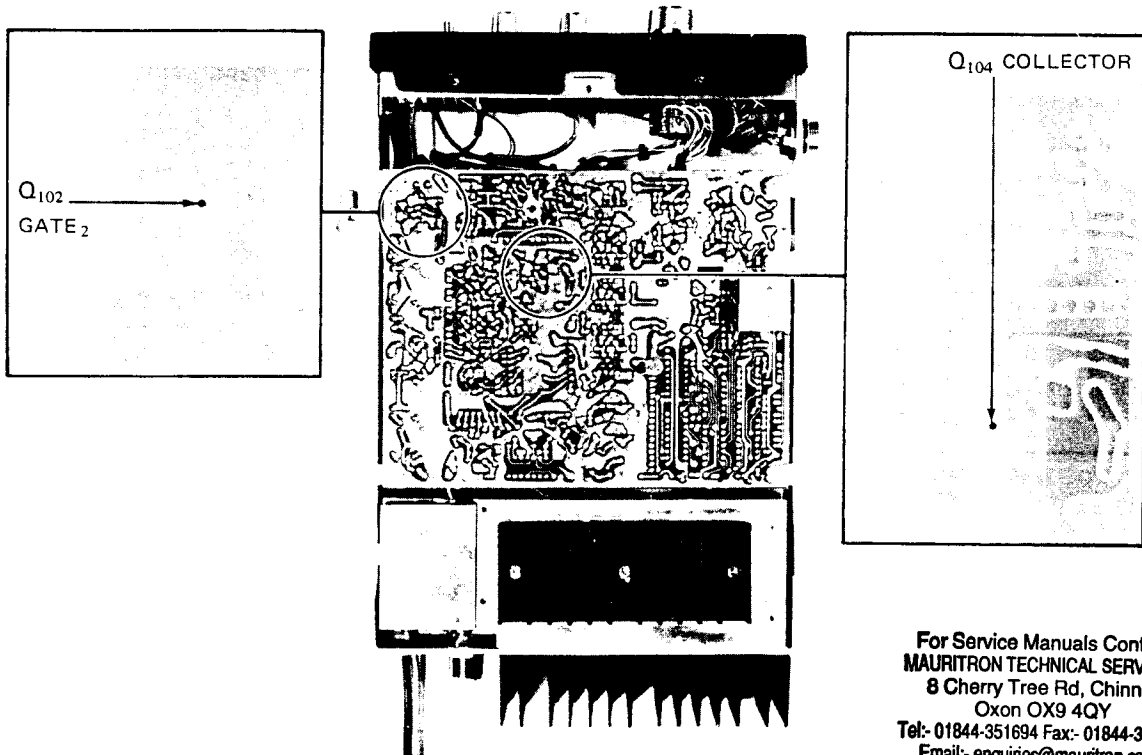
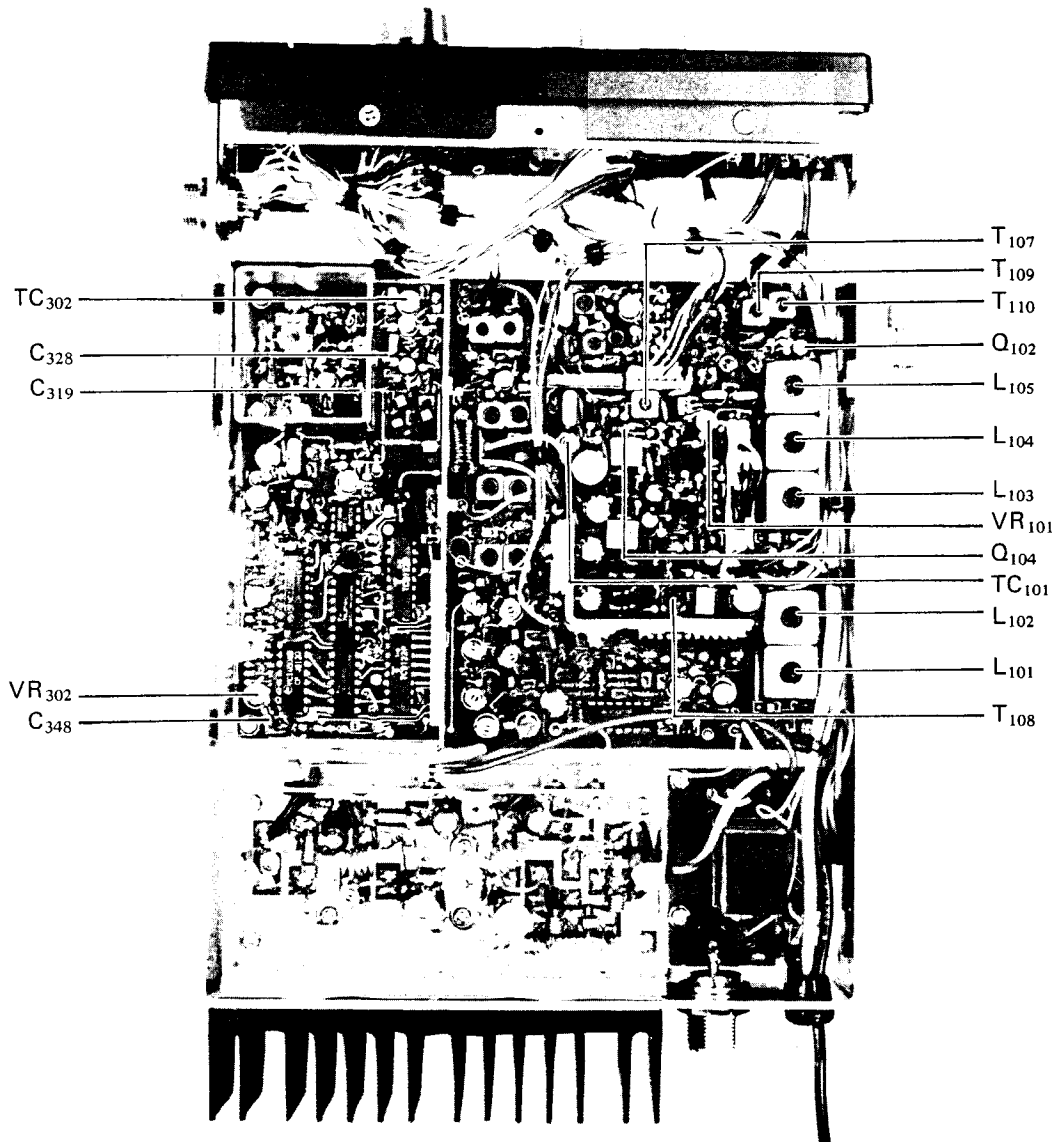

For Service Manuals Contact
MAURITRON TECHNICAL SERVICES
 8 Cherry Tree Rd, Chinnor
 Oxon OX9 4QY
 Tel: 01844-351694 Fax: 01844-352554
 Email: enquiries@mauritron.co.uk

D. Squelch

- 1) Connect the SSG to the ANT terminal with its output OFF. Preset SQ VR₂ to the 9 o'clock position and adjust VR₁₀₁ just to the threshold point where the BUSY lamp switches OFF.
- 2) Set the Channel Selector to F4, and the SSG output frequency to the F4 receive frequency. Now gradually increase the SSG output level. The squelch threshold should occur at 0.2 μ V, and be tight at 0.5 μ V.

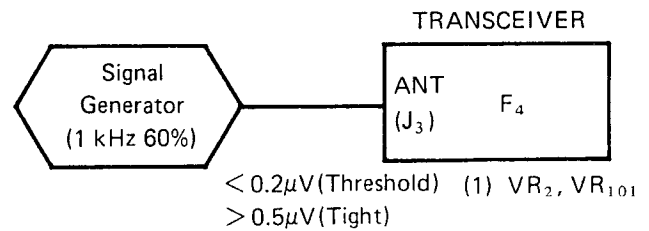

E. Audio Output Distortion and S/N

- 1) Connect the test equipment as in section C (Sensitivity).
- 2) Check that the audio output power is at least 1.5W (3.5V).
- 3) Check that the audio output distortion is less than 7% at 1.5 watts.
- 4) Check that the audio frequency response conforms to the following:

300 Hz	+10.5 dB	+2 -8 dB
1 kHz	0 dB	
3 kHz	-9.5 dB	+2 -8 dB

- 5) Check that the signal-to-noise ratio is better than 40 dB.

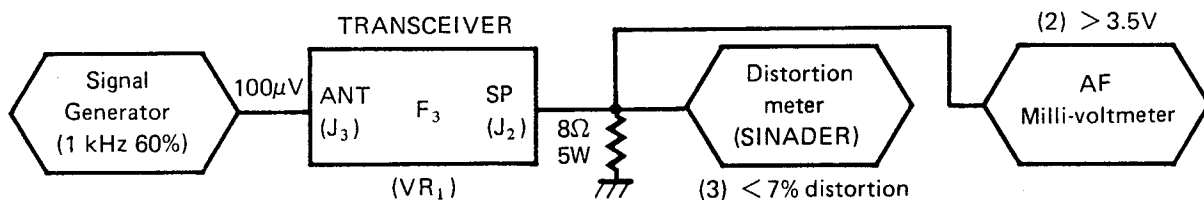

F. Spurious Response

- 1) Connect the test equipment as in section C and E.
- 2) Check that spurious response is less than 80 dB for all channels.

For Service Manuals Contact
MAURITRON TECHNICAL SERVICES
 8 Cherry Tree Rd, Chinnor
 Oxon OX9 4QY
 Tel:- 01844-351694 Fax:- 01844-352554
 Email:- enquiries@mauritron.co.uk

TROUBLESHOOTING

PLL

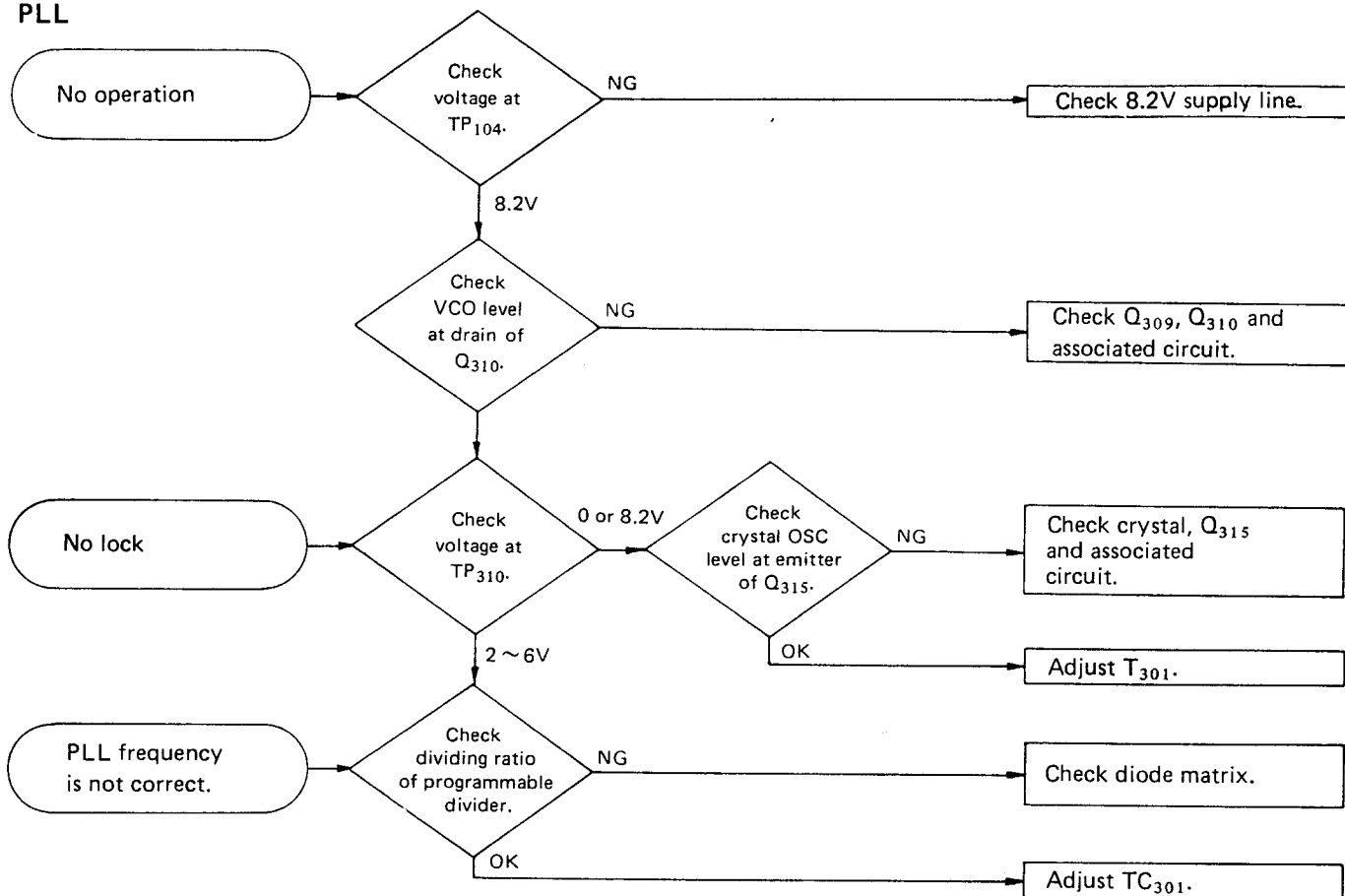

For Service Manuals Contact
MAURITRON TECHNICAL SERVICES
 8 Cherry Tree Rd, Chinnor
 Oxon OX9 4QY
 Tel:- 01844-351694 Fax:- 01844-352554
 Email:- enquiries@mauritron.co.uk

RECEIVER

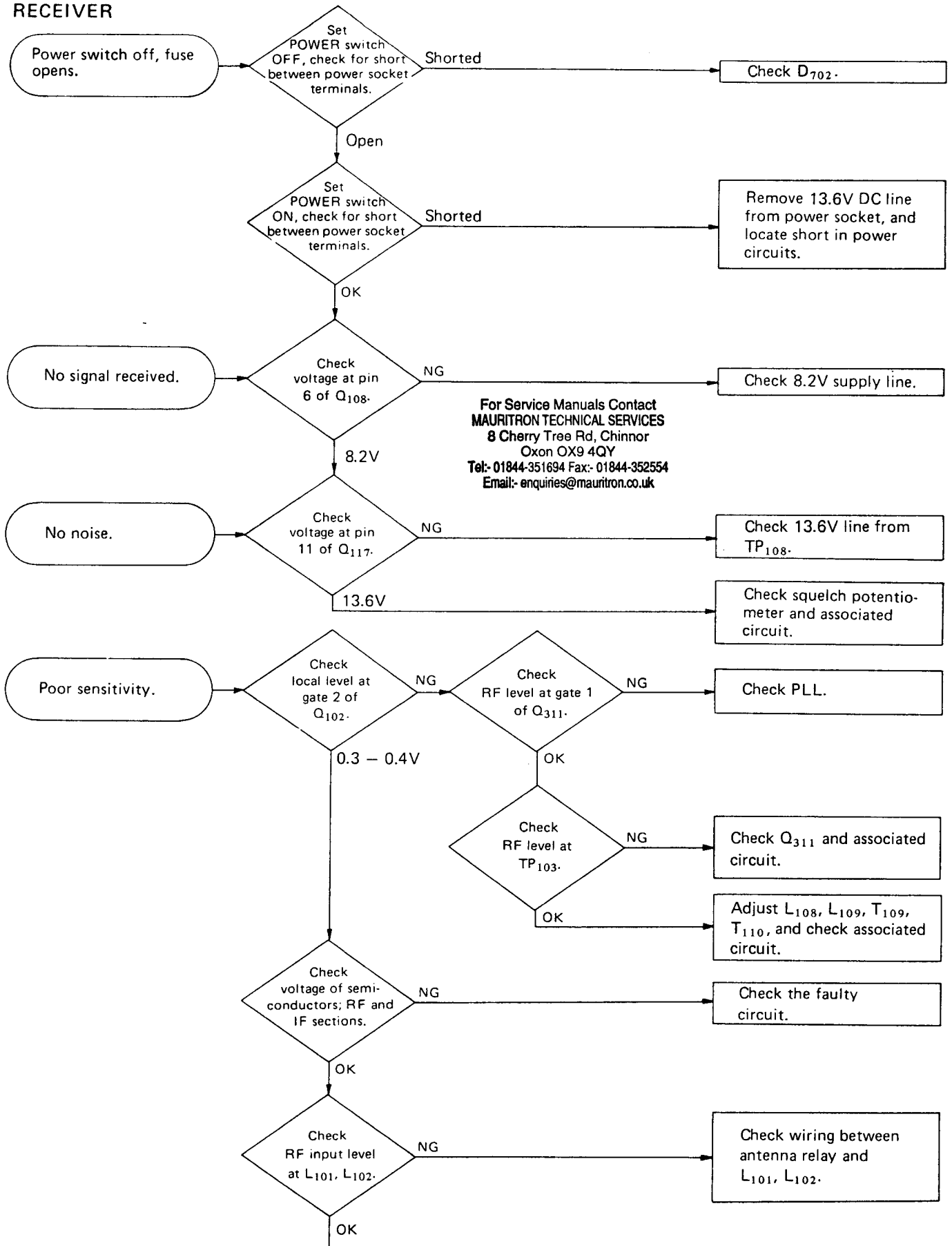

For Service Manuals Contact
MAURITRON TECHNICAL SERVICES
 8 Cherry Tree Rd, Chinnor
 Oxon OX9 4QY
 Tel: 01844-351694 Fax: 01844-352554
 Email: enquiries@mauritron.co.uk

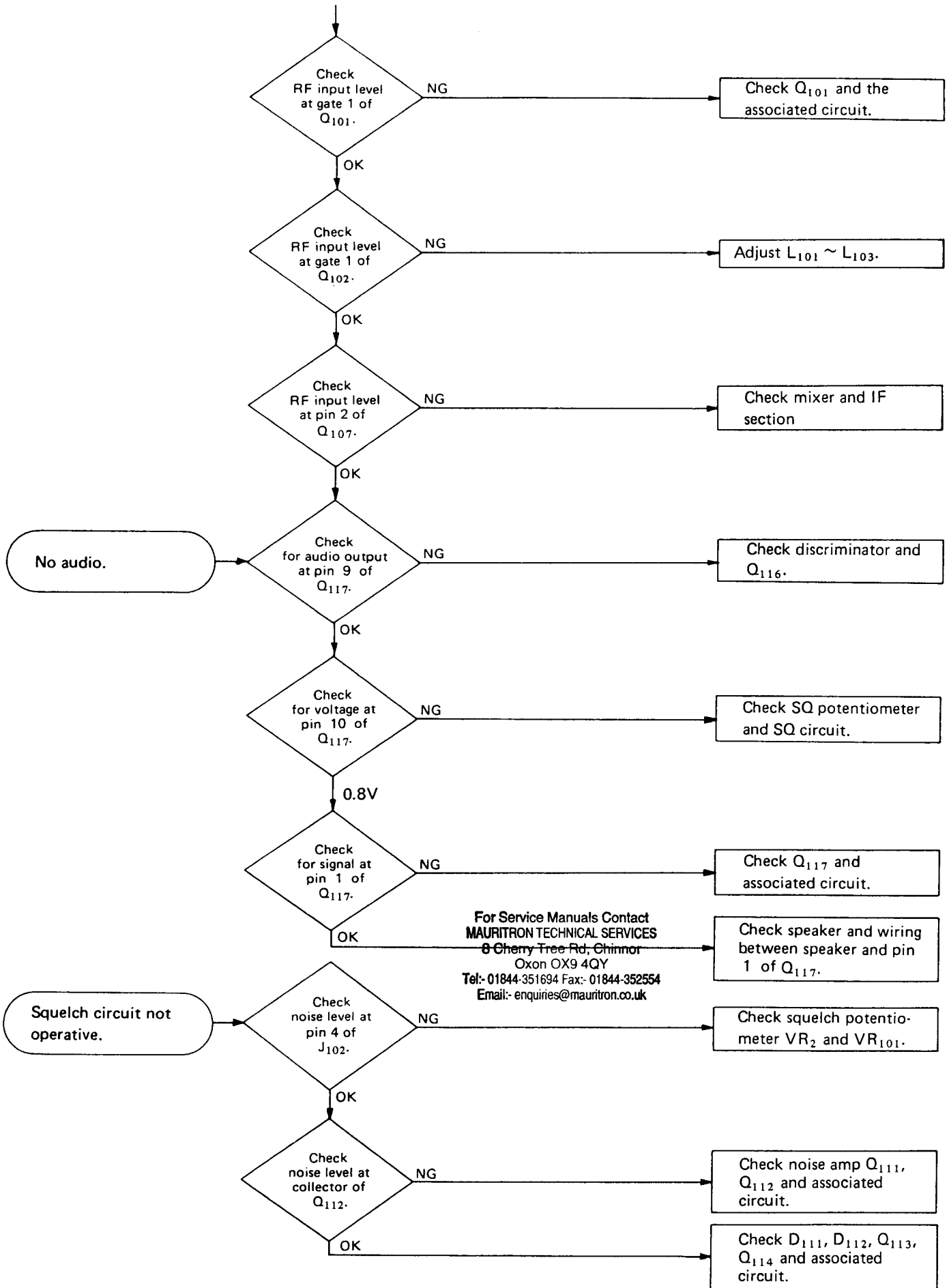

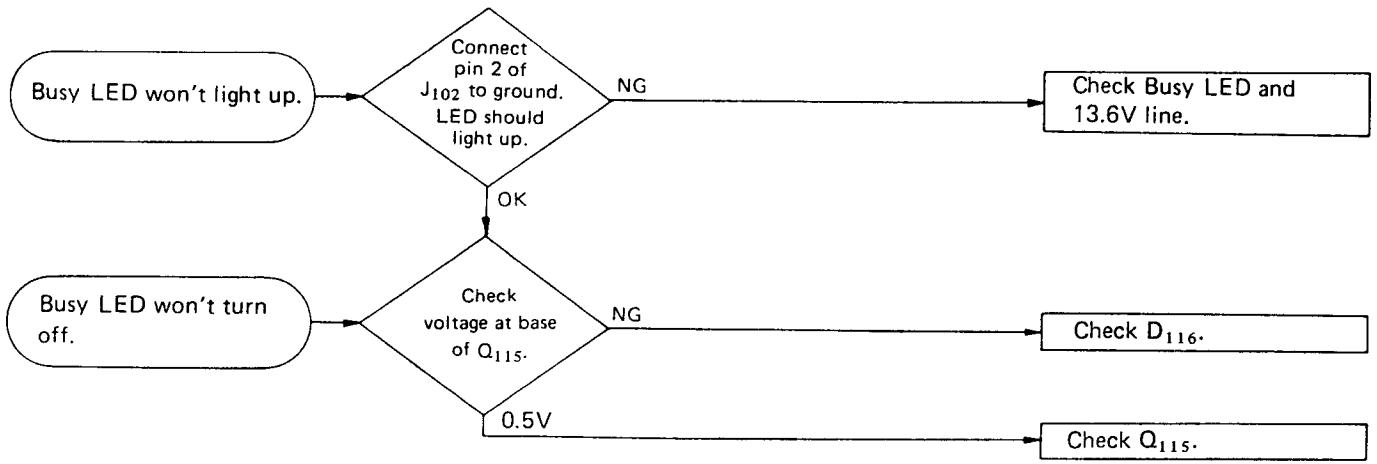

For Service Manuals Contact
MAURITRON TECHNICAL SERVICES
 8 Cherry Tree Rd, Chinnor
 Oxon OX9 4QY
 Tel:- 01844-351694 Fax:- 01844-352554
 Email:- enquiries@mauritron.co.uk

TRANSMITTER

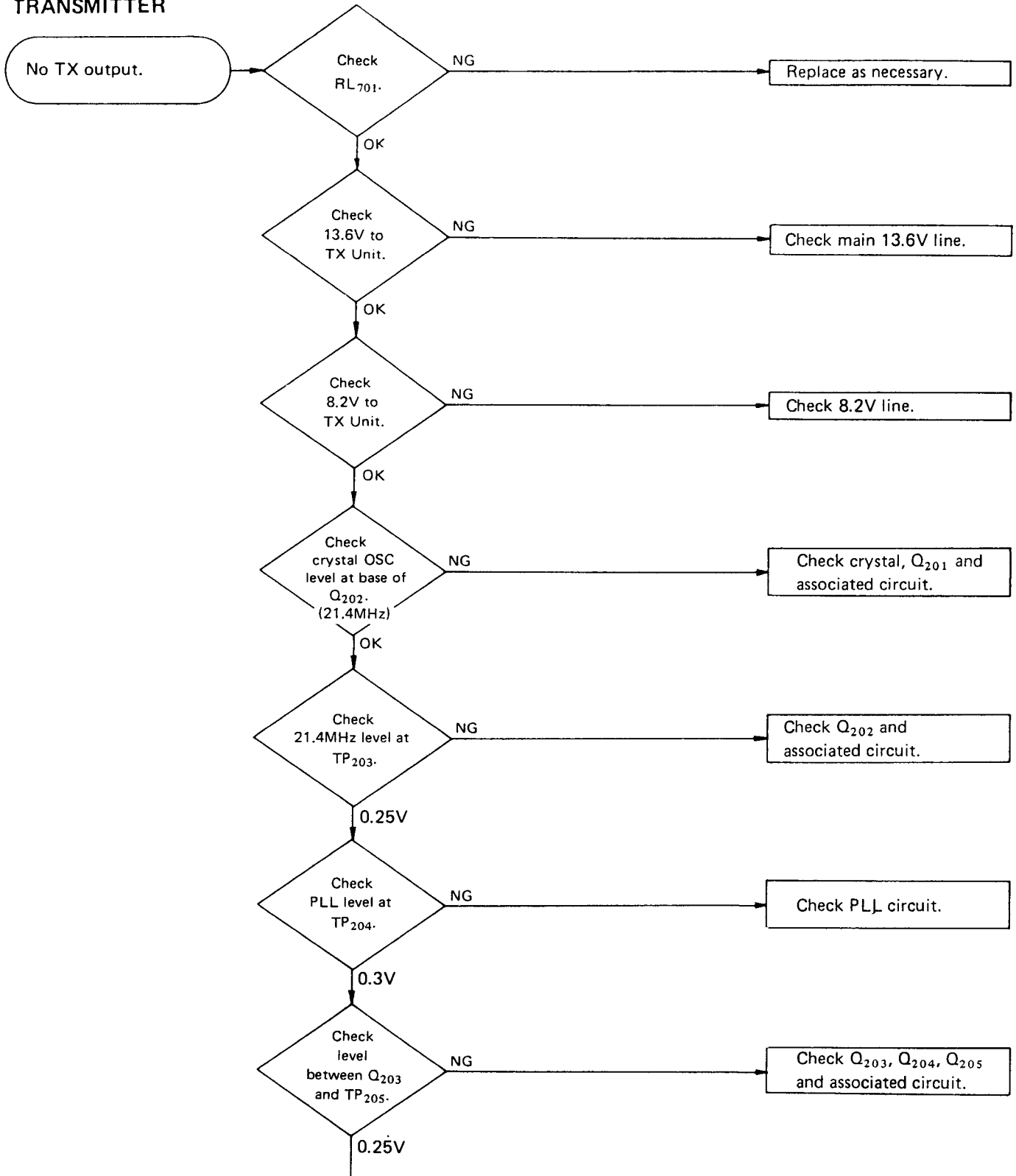

For Service Manuals Contact
MAURITRON TECHNICAL SERVICES
 8 Cherry Tree Rd, Chinnor
 Oxon OX9 4QY
 Tel: 01844-351694 Fax: 01844-352554
 Email: enquiries@mauritron.co.uk

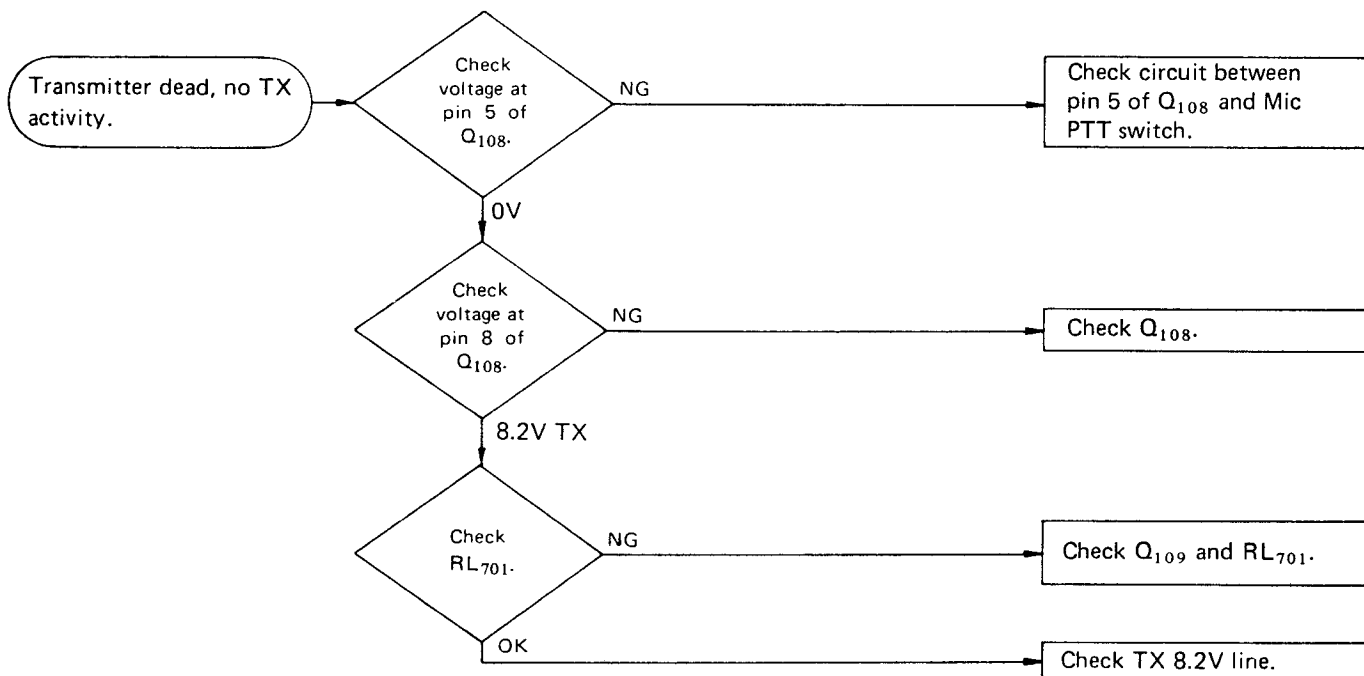
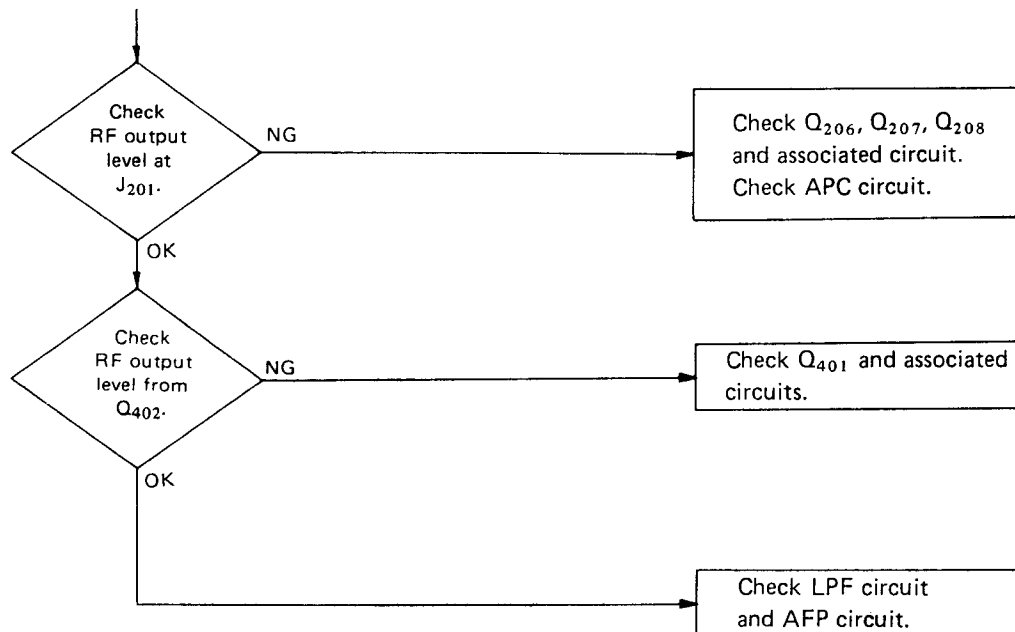

For Service Manuals Contact
MAURITRON TECHNICAL SERVICES
 8 Cherry Tree Rd, Chinnor
 Oxon OX9 4QY
 Tel: 01844-351694 Fax: 01844-352554
 Email: enquiries@mauritron.co.uk

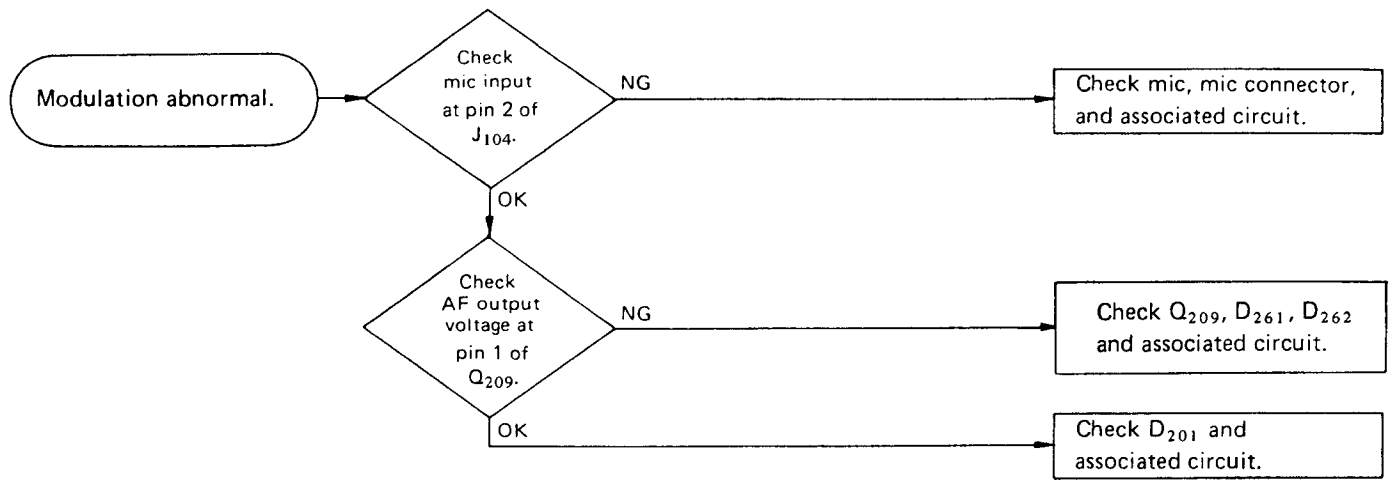

For Service Manuals Contact
MAURITRON TECHNICAL SERVICES
8 Cherry Tree Rd, Chinnor
Oxon OX9 4QY
Tel:- 01844-351694 Fax:- 01844-352554
Email:- enquiries@mauritron.co.uk

PARTS LIST

REPAIR PARTS

MAIN CHASSIS			Q107	G1090072	μ PC577H
Symbol No.	Part No.	Description	Q312	G1090299	μ PC14305
		POTENTIOMETER			
VR1, 2	J60800087	K1611008TE10KB 10K Ω			
		CAPACITOR			TRANSISTOR
C1	K10179015	Ceramic 0.01 μ F (CK45B1H103MYS)	Q115, 213, 305 306	G3304580B	2SC458B
			Q105, 106, 112- 114, 116	G3304600B	2SC460B
		SWITCH	Q111	G3304600C	2SC460C
S1	N3090020	SLP622014	Q103, 104, 110	G3305350B	2SC535B
	S5000056	(Switch Lever)	201, 202, 210		
S2	N2090019	8M3011	211, 315		
	S6000002	8Z0034 (Switch Lever)	Q214	G3208560B	2SB856B 2SA671B
S3	N0190098	SRN3038	Q109	G3312090D	2SC1209D
			Q204-206	G3319060	2SC1906
			Q313	G3320260	2SC2026
		RECEPTACLE	Q207	G3320530	2SC2053
J1	P0090262	FM214(2)-6S	Q208	G3325380	2SC2538
J3	P1090194	FM-MR-M2'			
J2	P1090005	SG8050			
J4 (with wire)	T9204365A	3191-02R1			FET
			Q310, 311, 316 317	G4800510C	3SK51-03
		SPEAKER	Q203	G4800590	3SK59
SP1	M4090049	SM-77KY-2 8 Ω	Q101, 102	G4800600	3SK60
	T9100302	Speaker Connection Cable	Q309	G3801680D	2SK168D
P1 (with wire)	T9204364	XHP-05			
P2 (")	T9204363	XHP-08			DIODE
P3 (")	T9204362	XHP-02	D106, 107, 111- 117	G2015550	Si 1S1555
P4 (")	T9204361	XHP-06	202, 209, 261		
P5 (")	T9204360	XHP-11	262, 301-307		
P6 (")	T9204359	XHP-08	309, 313		
			D201	G2090073	Varactor FC52M
		KNOB	D101-105, 203- 208, 311, 312	G2090107	" 1T25
	R3075730	FT-24SK (Channel)			
	R3075740	FT-15SK (VOL, SQL)	D308	G2090008	Zener WZ071
		For Service Manuals Contact MAURITRON TECHNICAL SERVICES 8 Cherry Tree Rd, Chinnor Oxon OX9 4QY Tel: 01844-351694 Fax: 01844-352554 Email: enquiries@mauritron.co.uk			CRYSTAL FILTER
			XF101	H1101990	21J2B2 (1/2) (Matched Pair)
			XF102	H1101990	" "
MAIN UNIT					
Symbol No.	Part No.	Description			
PB-2330D	F0002330D	Printed Circuit Board			CERAMIC FILTER
	C0023300	P.C.B. with Components	CF101, 102	H3900030	LF-B15
		IC			CERAMIC DISCRIMINATOR
Q117	G1090218	AN315	CD101	H7900010	455D
Q108	G1090222	MB3756			
Q314	G1090312	MC14504B			
Q308	G1090347	MC14568B			CRYSTAL
Q209, 212	G1090220	MLM2902P	X101	H0102050	HC-18/U 20.945MHz
Q304	G1090180	HD74LS02P	X201	H0102442	HC-18/T 21.4MHz
Q302	G1090196	HD74LS74AP	X301	H0102384	HC-18/U 7.5MHz
Q303, 307	G1090247	TC9122P			
Q301	G1090292	μ PB551C			

REPAIR PARTS

		RESISTOR					
R241	J20306220	Metallic Film	1W 22Ω	R120, 124, 140	J02245223	Carbon Film	¼W SJ 22KΩ
R317	J02245220	Carbon Film	¼W SJ 22Ω	177, 183, 210			
R115, 219, 383	J02245470	" "	" " 47Ω	224, 229, 235			
R239, 322, 326	J02245680	" "	" " 68Ω	306, 307, 382			
390				391			
R176, 185	J02245820	" "	" " 82Ω	R111, 270	J02245273	" "	" " 27KΩ
R107, 310	J01245101	" "	" TJ 100Ω	R346, 348, 350	J01215303	" "	1/8W TJ 30KΩ
R116, 126, 164	J02245101	" "	" SJ 100Ω	352, 354, 356			
208, 214, 220				R162, 172, 186	J02245333	" "	¼W SJ 33KΩ
233, 240, 318				206, 265, 280			
327, 357, 381				301, 313			
387				R312	J01245333	" "	" TJ 33KΩ
	J01245100	" "	" " 120Ω	R103, 138, 168	J02245473	" "	" SJ 47KΩ
R212, 342	J02245221	" "	" " 220Ω	203, 320, 321			
R106	J02245271	" "	" " 270Ω	343			
R341	J01245271	" "	" TJ 270Ω	R345, 349, 353	J01215623	" "	1/8W TJ 62KΩ
R297	J02245331	" "	" SJ 330Ω	R293	J01215683	" "	" " 68KΩ
R308	J02245391	" "	" " 390Ω	R101, 102, 108-	J00215104	" "	" SJ 100KΩ
R263	J02245471	" "	" " 470Ω	110, 221, 222			
R213	J01245471	" "	" TJ 470Ω	226, 227, 231			
R215, 344	J02245561	" "	" SJ 560Ω	232			
R225, 230, 236	J02245681	" "	" " 680Ω	R174, 305, 316	J02245104	" "	¼W " 100KΩ
R117, 118, 121	J02245102	" "	" " 1KΩ	319, 323, 385			
122, 125, 127				386			
129, 135, 165				R273	J02245124	" "	" " 120KΩ
169, 181, 207					J01215154	" "	1/8W TJ 150KΩ
309				R130, 132, 303	J02245154	" "	¼W SJ 150KΩ
R286, 296	J01245102	" "	" TJ 1KΩ	R104	J02245184	" "	" " 180KΩ
R128, 131, 133	J02245222	" "	" SJ 2.2KΩ	R113, 114, 171	J02245224	" "	" " 220KΩ
134, 184, 267				264, 272			
281, 360				R289	J01215333	" "	1/8W TJ 33KΩ
R223, 228, 314	J02245272	" "	" " 2.7KΩ	R266	J02245334	" "	¼W SJ 330KΩ
R139, 141, 161	J02245332	" "	" " 3.3KΩ	R274	J02245474	" "	" " 470KΩ
170, 178, 179							
217, 234, 237							
R315	J01245103	" "	" TJ 10KΩ			POTENTIOMETER	
R119, 123, 173	J02245472	" "	" SJ 4.7KΩ	VR101, 261-	J51745103	H0651A013-10KB	10KΩ
180, 182, 209				263			
R167, 268, 269	J02245562	" "	" " 5.6KΩ	VR201	J51724103	PN822H 103H	10KΩ
R163, 175, 283	J02245682	" "	" " 6.8KΩ	VR301-303	J51745473	H0651A017-47KB	47KΩ
389							
R324, 384	J02245822	" "	" " 8.2KΩ			CAPACITOR	
R105, 136, 137	J02245103	" "	" " 10KΩ	C226, 234	K08179003	Ceramic Disc	AK 0.35pF
166, 204, 205						(RAU04AK0R35C)	
238, 261, 262				C104, 114, 117	K02182010	" "	63WV CH 1pF
275, 276, 278				0204, 0205		(RD870-1CG010C63V)	
279, 284				C101, 105, 209	K02182030	" "	" " 3pF
R287, 291, 292	J01215103	" "	1/8W TJ 10KΩ			(RD870-1CG030C63V)	
294, 295				C246, 251, 316	K02182050	" "	" " 5pF
R112	J02245123	" "	¼W SJ 12KΩ			(RD870-1CG050C63V)	
R187, 201, 202	J02245153	" "	" " 15KΩ	C220, 228, 236	K02183060	" "	" " 6pF
216, 271, 285						(RD870-1CG060D63V)	
302, 304, 311				C127	K02183070	" "	" " 7pF
325, 359, 388						(RD870-1CG070D63V)	
R347, 351, 355	J01215153	" "	1/8W TJ 15KΩ	C131	K02183100	" "	" " 10pF
R282, 358	J02245183	" "	¼W SJ 18KΩ			(RD870-1CG100D63V)	
				C314	K06183100	" "	" UJ 10pF
						(RD870-1UJ100D63V)	

For Service Manuals Contact
MAURITRON TECHNICAL SERVICES
 8 Cherry Tree Rd, Chinnor
 Oxon OX9 4QY
 Tel: 01844-351694 Fax: 01844-352554
 Email: enquiries@mauritron.co.uk

C367	K02185180	Ceramic Disc 63WV CH 18pF (RD870-1CG180J63V)	C309	K70167334	Tantalum 35WV 0.33μF (CS15E1VR33M1S)
C122	K05185220	" " " RH 22pF (RD870-1RG220J63V)	C167, 185, 191 265, 266, 270 271, 303, 304	K70147105	" 25WV 1μF (CS15E1E010M1S)
C364	K02185330	" " " CH 33pF (RD871-1CG330J63V)	C187, 190, 201 272	K70127225	" 16WV 2.2μF (CS15E1C2R2M1S)
C171	K06185330	" " " UJ 33pF (RD870-1UJ330J63V)	C132, 183, 261	K70127475	" " 4.7μF (CS15E1C4R7M1S)
C207, 210	K05185390	" " " RH 39pF (RD871-1RG390J63V)	C242, 245, 248	K70127685	" " 6.8μF (CS15E1C6R8M1S)
C206, 229, 237 252, 253, 269 369	K02185390	" " " CH 39pF (RD871-1CG390J63V)	C135, 140, 175 186, 189, 193 196, 198, 262 275, 322, 338 341, 343, 349 371	K70127106	" " 10μF (CS15E1C100M1S)
C221, 249, 365	K02185560	" " " " 56pF (RD872-2CG560J63V)	C194, 268	K50177102	Mylar 0.001μF (50F2U102M)
C173, 351	K06185101	" " " UJ 100pF (RD870-1CG010C63V)	C139, 152, 153	K50177222	" 0.0022μF (50F2U222M)
C182, 308	K02185101	" " " CH 100pF (RD874-2CG101J63V)	C192	K50177332	" 0.0033μF (50F2U332M)
C172, 352	K06185221	" " " " 220pF (RD873-2UJ221J63V)	C181, 267	K50177472	" 0.0047μF (50F2U472M)
C203, 204	K06185271	" " " " 270pF (RD874-2UJ271J63V)	C263	K50177223	" 0.022μF (50F2U223M)
C195	K10186331	" " " B 330pF (RD870-1B331K63V)	C144-148	K50177473	" 0.047μF (50F2U473M)
C150	K10186471	" " " " 470pF (RD870-1B471K63V)	C344	K50177104	" 0.1μF (50F2U104M)
C184	K10186821	" " " " 820pF (RD870-1B821K63V)	C143	K40129008	Electrolytic 16WV 33μF (16RE33)
C108-110, 112 123-125, 130 134, 136-138 141, 149, 156- 158, 0206, 0207 211-215, 222 224, 230, 232 238-241, 243 244, 247, 250 254, 255, 264 273, 274, 276-279, 281 282, 289-291 293-296, 301 302, 306, 307 310, 317-321 323, 325-330 336, 337, 345 346, 353-362 368, 374	K10186102	" " " " 0.001μF (RD870-1B102K63V)	C162, 164, 166 292	K40129007	" " 100μF (16RE100)
			C199, 297	K40129006	" " 470μF (16RE470)
					TUNING CAPACITOR (See Band Table, page 2-27)
			C101, 102, 106 107, 111, 113 115, 116, 118 119, 120, 0201 0202, 0203 C216, 217, 219 225, 227, 233 235 C311, 312, 313 315		For Service Manuals Contact MAURITRON TECHNICAL SERVICES 8 Cherry Tree Rd, Chinnor Oxon OX9 4QY Tel: 01844-351694 Fax: 01844-352554 Email: enquiries@mauritron.co.uk
C126, 128, 129 133, 142, 151 161, 163, 165 174, 202, 205 208, 331, 340 342, 347, 348 350, 372, 373	K10179015	" " " " 0.01μF (CK45B1H103MYS)			
					TRIMMER CAPACITOR
C154, 197	K70167104	Tantalum 35WV 0.1μF (CS15E1V0R1M1S)	TC302	K91000028	ECV-1ZW 10x53 10pF
C305	K70167154	" " 0.15μF (CS15E1VR15M1S)	TC101, 201, 203 205, 206, 301	K91000029	ECV-1ZW 20x53 20pF
			TC202, 204	K91000030	ECV-1ZW 40x53 40pF

REPAIR PARTS

		INDUCTOR			TRANSISTOR
L101-105	L0020706		Q401	G3325390	2SC2539
	L9190015	Shield Case (for L101-L105)	Q402	G3326300	2SC2630
L106, 108, 201-205, 215, 307-309, 311, 312	L1020081A				
L109	L1190017	FL5H-102K 1mH	D401-403	G2090118	DIODE Schottky Barrier 1SS97
L110	L1190038	FL5H-271K 270µH			
L206, 208, 212 214, 314-316	L0020342				RESISTOR
L207, 210	L0020886		R402	J02245100	Carbon Film ¼W TJ 10Ω
L261, 262	L1020079A		R401	J01245121	" " " SJ 120Ω
L263	L2030060				
L301	L1190119	FL3H-1R5M 1.5µH			
L304	L0020724				CAPACITOR
L211, 302, 303 310, 313	L1020469		C426	K02183090	Ceramic Disc 63WV CH 9pF (RD870-1CG090D63V)
			C422-425, 444	K02185180	" " " " 18pF (RD870-1CG180J63V)
		TRANSFORMER	C433	K02185390	" " " " 39pF (RD871-1CG390J63)
T107	L0020647	119CC-11114N			
T108	L0020649	7MC-5896Y	C440-442	K02185121	" " " " 120pF (RD874-2CG121J63V)
T109, 110	L0020345	113SN-6146F			
T201	L0021153		C403, 409, 418 419	K02185560	" " " " 56pF (RD872-2CG560J63V)
T202, 203	L0020919				
T204-209	L0020429	113SN-4530Y	C401	K02185680	" " " " 68pF (RD873-2CG680J63V)
T301	L0021157	L-1S6-B			
			C408	K02185330	" " " " 33pF (RD871-1CG330J63V)
		CONNECTOR	C406, 414, 436	K02185101	" " " " 100pF (RD874-2CG101J63V)
J103	P0090191	B02B-XH			
J101	P0090194	B05B-XH	C405, 413, 415 428, 429	K10186102	" " " B 0.001µF (RD870-1B102K63V)
J104	P0090195	B06B-XH			
J102	P0090197	B08B-XH	C435	K02185220	" " " CH 22pF (RD871-1CG220J63V)
J105	P0090092	3022-08A			
J301	P0090242	3022-18A	C407, 417	K10179024	" " " " 0.01µF (CK45B1H103MYS)
J201	P1090210	TMP-JV			
			C430-432	K21170002	Feed Through 0.001µF (ECKY1H-102WE)
		TERMINAL POST	C412, 416, 420	K40129029	Electrolytic 16WV 100µF (16RJ2100)
	Q5000036	TP-G			
	R0075780	HEAT SINK			
	R0075790	HEAT SINK SPACER			TUNING CAPACITOR
	R0075800	SHIELD PLATE (S)			(See Band Table, page 2-27)
	R0078940	SHIELD PLATE (L)	C404, 410, 426		
	R0075810	PLL SHIELD CASE	427, 434, 443		
	R0075820	PLL SHIELD CASE COVER	445		
	R0075830	VCO CASE			
	R0075840	VCO CASE COVER			
		For Service Manuals Contact MAURITRON TECHNICAL SERVICES 8 Cherry Tree Rd, Chinnor Oxon OX9 4QY Tel: 01844-351894 Fax: 01844-352554 Email: enquiries@mauritron.co.uk			TRIMMER CAPACITOR
			TC401,403,406	K91000030	ECV-1ZW 40x53 40pF
			TC405	K91000047	2222-808-32409 40pF
			TC404	K91000057	2222-808-32809 80pF
P.A. UNIT					
Symbol No.	Part No.	Description			INDUCTOR
PB-2332	F0002332	Printed Circuit Board	L401	L0021151A	
	C0023320	P.C.B. with Components	L402, 406	L1020079A	
			L403, 407	L0021148A	

ACCESSORIES		
Symbol No.	Part No.	Description
	M3090020	MICROPHONE (YM-31)
	P1090021	(Microphone Plug FM-146P)
	T9013415	DC POWER CORD
	P1090124	(Plug 3191-02P1)
	Q2000001	(Fuse Holder SN1101)
		FUSE
	Q0000008	15A
		MOUNT BRACKET
	D6000024	FMB-4-1 (with Mount Screws)
		DIODE ARRAY
	G2090213	03-0042 (Not programmed)

For Service Manuals Contact
MAURITRON TECHNICAL SERVICES
 8 Cherry Tree Rd, Chinnor
 Oxon OX9 4QY
 Tel:- 01844-351694 Fax:- 01844-352554
 Email:- enquiries@mauritron.co.uk

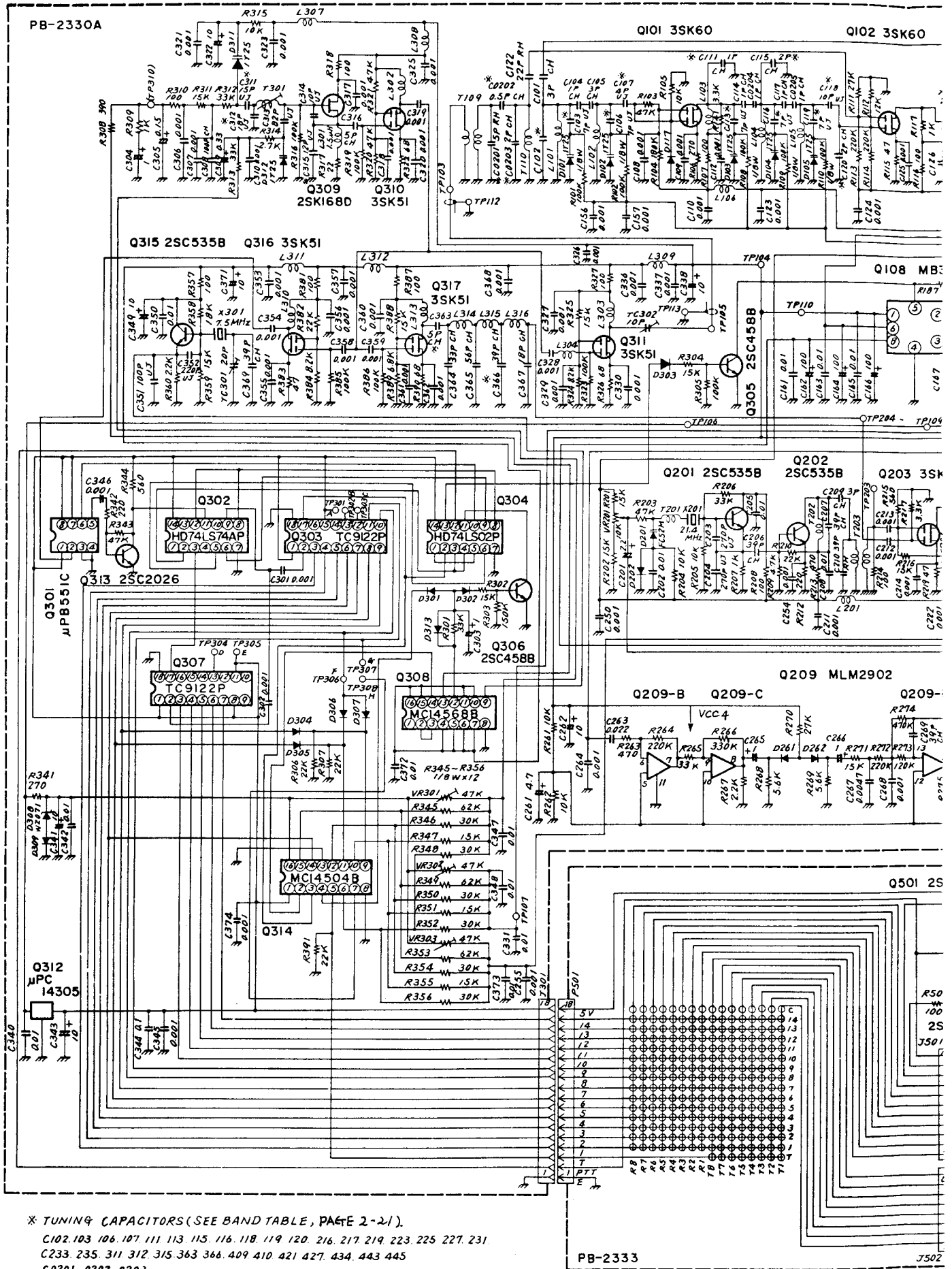

* TUNING CAPACITORS (SEE BAND TABLE, PAGE 2-21).
 C102, 103, 106, 107, 111, 113, 115, 116, 118, 119, 120, 216, 217, 219, 223, 225, 227, 231,
 C233, 235, 311, 312, 315, 363, 366, 409, 410, 421, 427, 434, 443, 445
 C0201, 0202, 0203

For Service Manuals
MAURITRON SERVICES
 8 Cherry Tree Road, Chinnor
 Oxfordshire, OX9 4QY.
 Tel (01844) 351694
 Fax (01844) 352554
 email - mauritron@dia1.pipex.com

PB-2333

J502

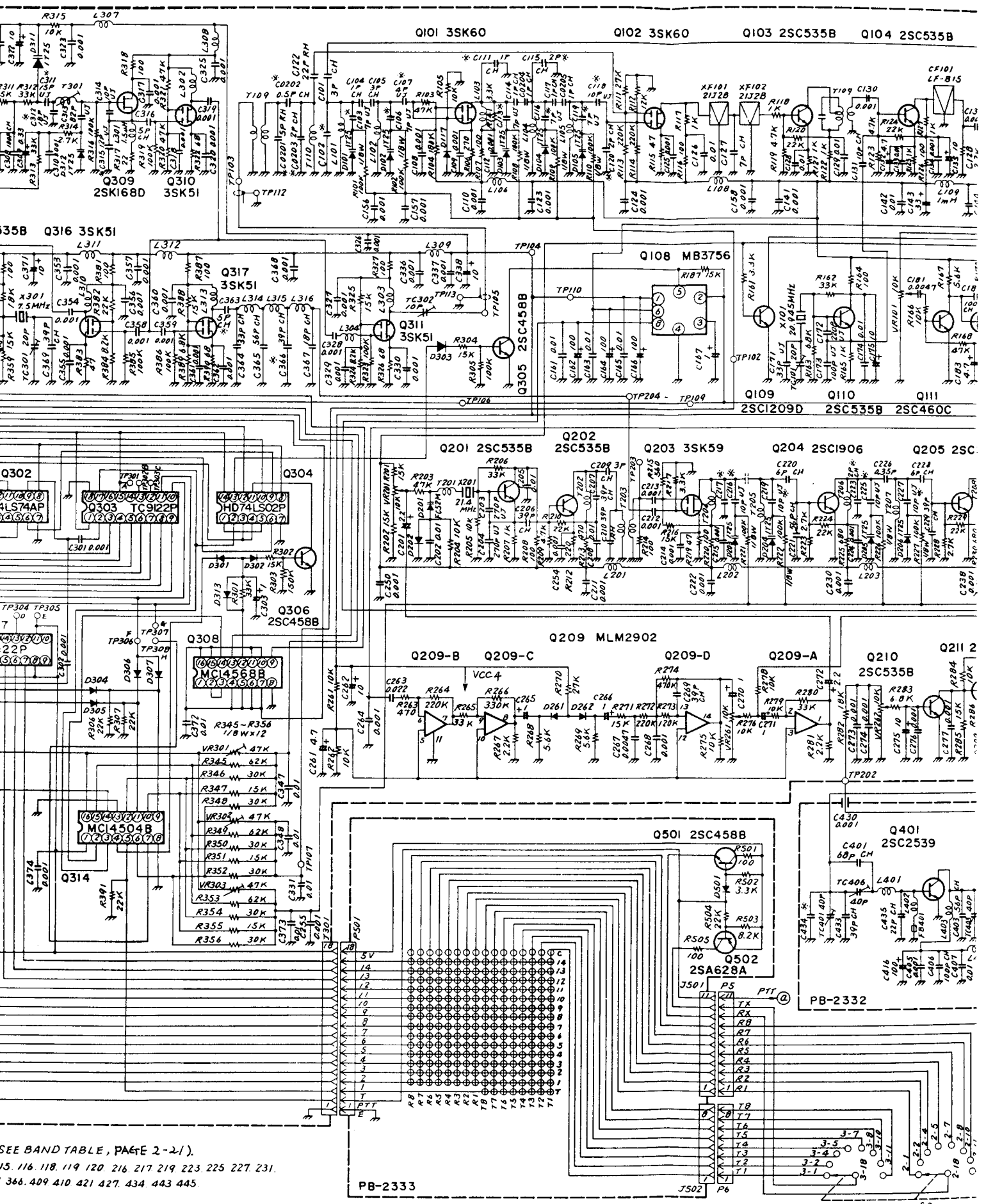

SEE BAND TABLE, PAGE 2-21).
 115. 116. 118. 119. 120. 216. 217. 219. 223. 225. 227. 231.
 368. 409. 410. 421. 427. 434. 443. 445

For Service Manuals Contact
MAURITRON TECHNICAL SERVICES
 8 Cherry Tree Rd, Chinnor
 Oxon OX9 4QY
 Tel: 01844 351694 Fax: 01844 352554
 Email: enquiries@mauritron.co.uk

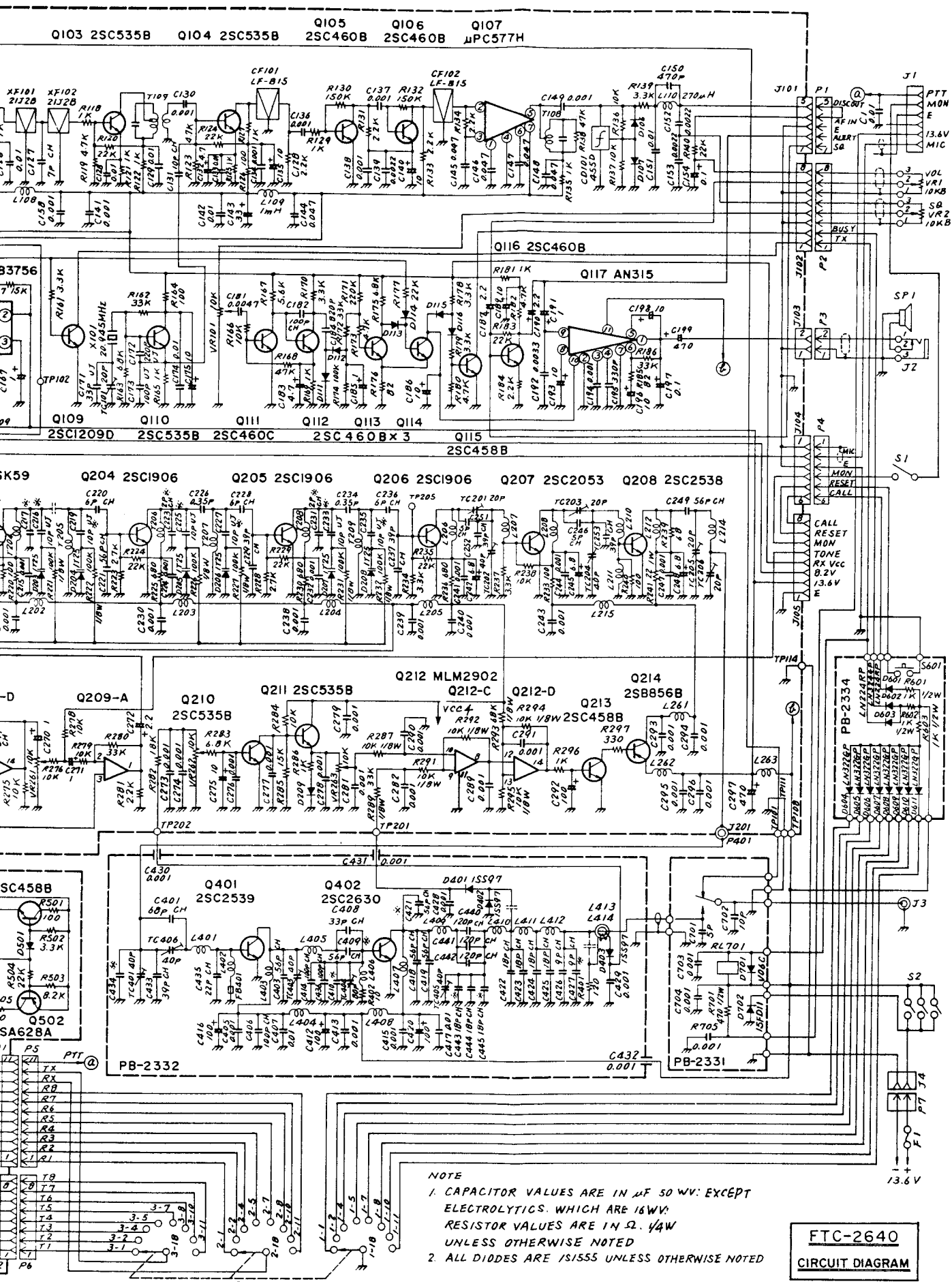

NOTE
 1. CAPACITOR VALUES ARE IN μF 50 WV, EXCEPT
 ELECTROLYTICS, WHICH ARE 16 WV.
 RESISTOR VALUES ARE IN Ω , $\frac{1}{4}\text{W}$
 UNLESS OTHERWISE NOTED
 2. ALL DIODES ARE 1S1555 UNLESS OTHERWISE NOTED

FTC-2640
CIRCUIT DIAGRAM

For Service Manuals Contact
MAURITON TECHNICAL SERVICES
 8 Cherry Tree Rd, Chinnor
 Oxon OX9 4QY
 Tel: 01844-351694 Fax: 01844-352564
 Email: enquiries@mauriton.co.uk

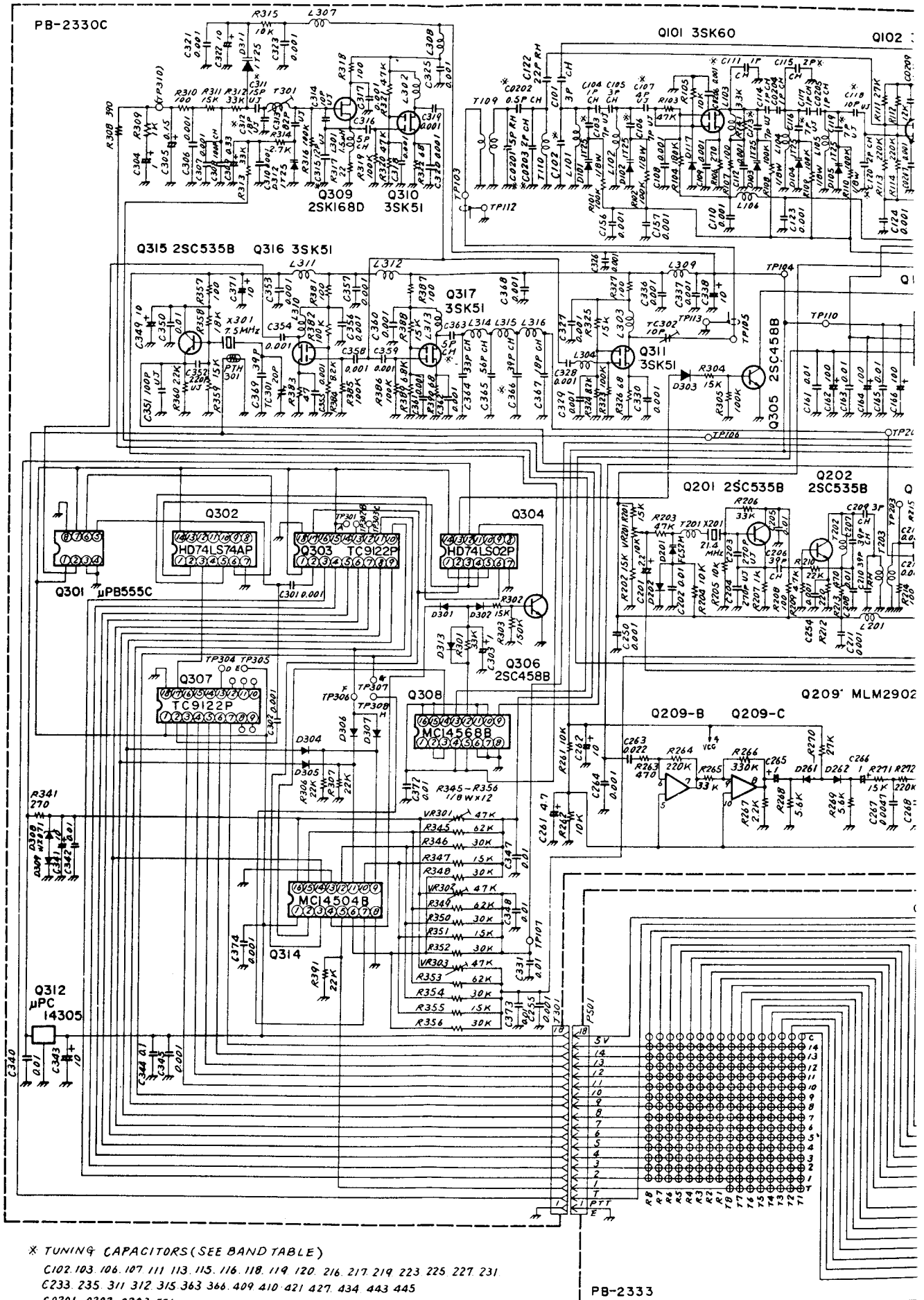

* TUNING CAPACITORS (SEE BAND TABLE)

- C102 103 106 107 111 113 115 116 118 119 120 216 217 219 223 225 227 231
- C233 235 311 312 315 363 366 409 410 421 427 434 443 445
- C0201 0202 0203 101

For Service Manuals Contact
MAURITRON TECHNICAL SERVICES
 8 Cherry Tree Rd, Chinnor
 Oxon OX9 4QY
 Tel: 01844-351694 Fax: 01844-352554
 Email: enquiries@mauritron.co.uk

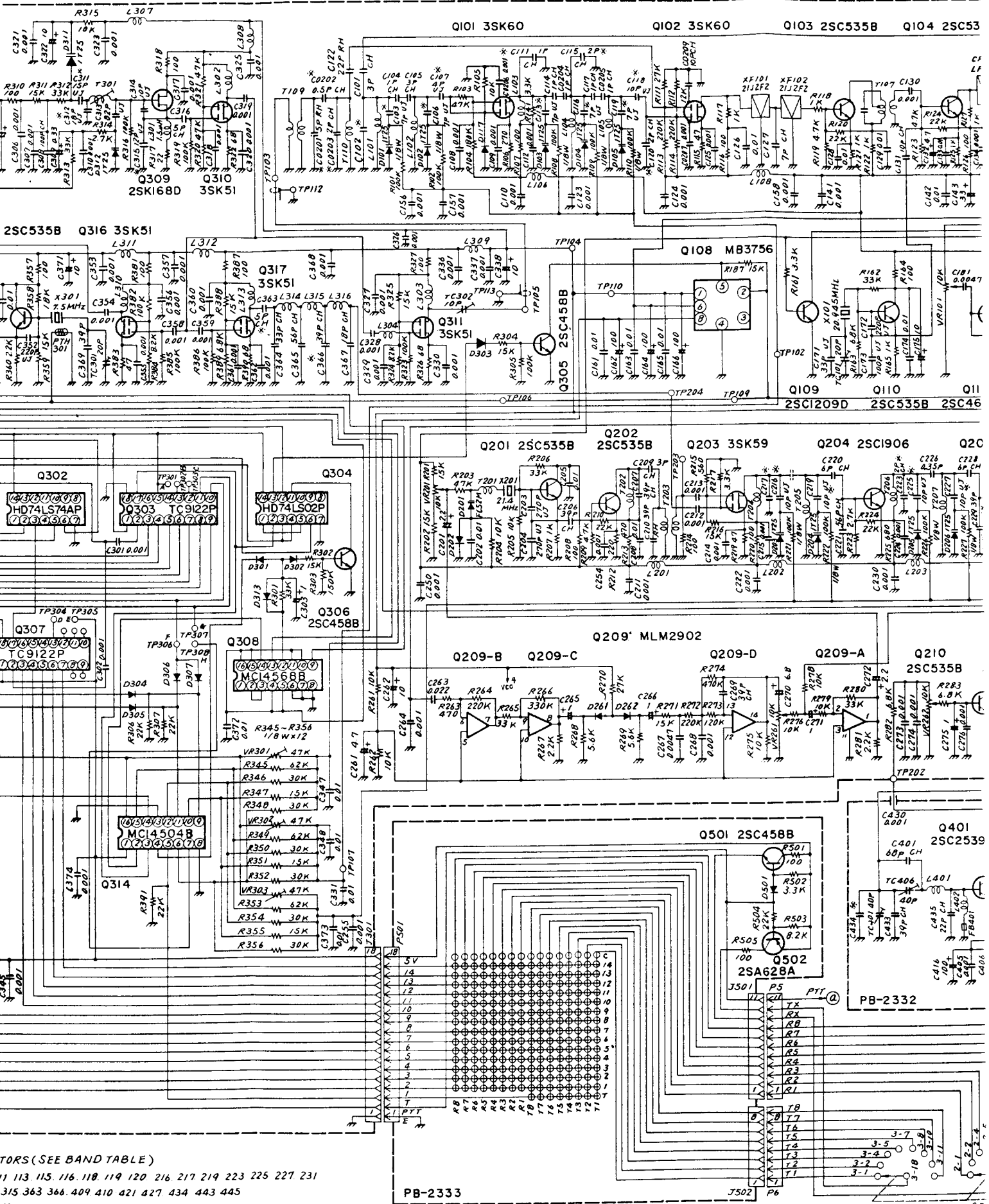

TORS (SEE BAND TABLE)
 111 113 115 116 118 119 120 216 217 219 223 225 227 231
 315 363 366 409 410 421 427 434 443 445

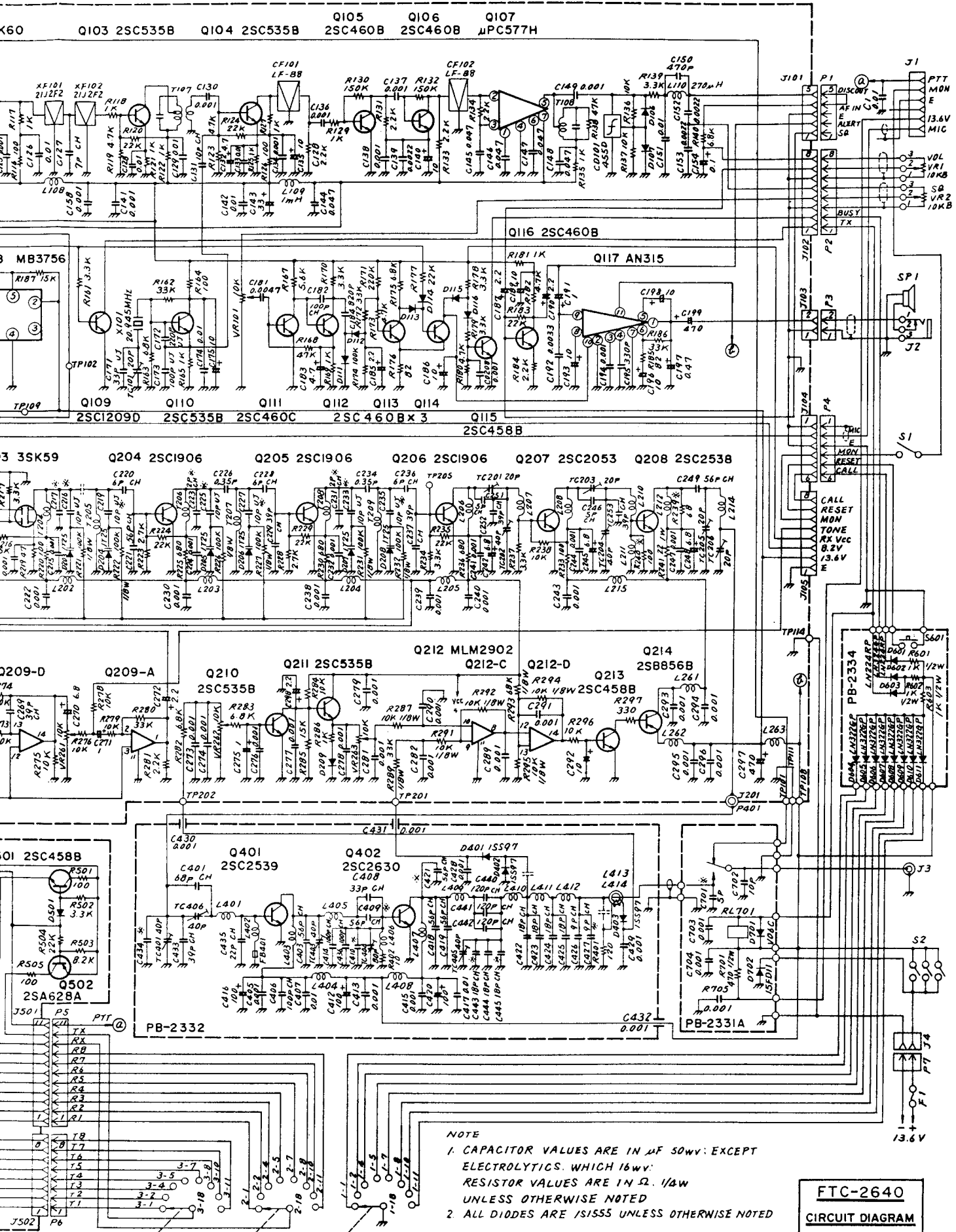

NOTE
 1. CAPACITOR VALUES ARE IN μ F 50WV; EXCEPT ELECTROLYTICS, WHICH 16WV; RESISTOR VALUES ARE IN Ω , 1/8W UNLESS OTHERWISE NOTED
 2. ALL DIODES ARE 1S1555 UNLESS OTHERWISE NOTED

FTC-2640
CIRCUIT DIAGRAM

For Service Manuals Contact
MAURITRON TECHNICAL SERVICES
 8 Cherry Tree Rd, Chinnor
 Oxon OX9 4QY
 Tel: 01844-351694 Fax: 01844-352554
 Email: enquiries@mauritron.co.uk

12.5kHz/STEP MODEL